



[marine.vdo-gauges.com](http://marine.vdo-gauges.com)

# Marine Catalog

For the Marine Enthusiast

- Instruments
- Senders
- Sensors
- Accessories
- Camera Systems



**VDO**



## The Elegance of Precision

At VDO, we are focused on providing our customers with the best possible instrumentation – a goal that we’ve pursued since 1920. We continue to work to deliver the functionality, durability and high quality finish that have earned our products a best-in-class reputation, worldwide. At the same time, we strive to make our instrumentation more efficient, affordable and useful to our customers.

While we are aware of the vital role of our instruments as a human-machine interface and the importance of factors such as ergonomics, cost and reliability, we haven’t neglected aesthetics. Our latest styles include a whole new family of instruments and three exciting models.

The Elegance of Precision continues on!

## Table of Contents

<b>New Products .....</b>	<b>8-9</b>
<b>Camera Systems .....</b>	<b>12-13</b>
<b>Viewline Instruments .....</b>	<b>14-29</b>
Viewline Onyx.....	14-19
Viewline Ivory .....	20-25
Viewline Sterling.....	26-27
<b>Vision Instruments.....</b>	<b>30-35</b>
Vision Chrome.....	30-32
Vision Black .....	33-35
<b>Cockpit International Instruments .....</b>	<b>36-38</b>
<b>OceanLink Instruments .....</b>	<b>39</b>
<b>Hourmeters .....</b>	<b>40-41</b>
<b>Senders and Switches .....</b>	<b>42-55</b>
Pressure Senders & Switches .....	43-44
Temperature Senders & Switches .....	45-47
Speedometer & Tachometer Senders.....	48
Rudder Angle Senders.....	48
ALAS I Fuel Senders .....	50
ALAS I Fuel Senders .....	51
ALAS II Fuel Senders .....	52-53
Tube Type Fuel Senders.....	54-55
Water Level Senders .....	55
<b>Accessories and Service Parts .....</b>	<b>56-59</b>



# VDO - A heritage of quality and innovation



While our latest instruments offer revolutionary technologies such as GPS speed senders and plug-and-play solutions, these innovations are just a part of a VDO technology evolution that reaches back over 100 years.

From the first “Eddy current” speedometer invented in 1902 by Otto Schulze, to our latest Viewline gauge series, VDO has been at the leading edge of instrumentation technology and one of the industry’s most trusted instrument brands.

## Staying on the edge with innovation

The VDO instrument evolution has included innovations such as the introduction of stepper motors that delivered greater precision and accuracy than ever before. Our Spin-Lok™ mounting system made installations easier, faster and more secure. We pioneered ‘through dial lighting’ as well as LED dial illumination, to make our gauges easier to read and more stylish – an accomplishment matched by very few in the marine market. VDO in-gauge LCD screens brought new monitoring capabilities to instrumentation, and our self-contained electronics eliminated the need for additional components in high-tech instrumentation.

Today, our innovation evolution extends beyond gauges. The adjustable design on our VDO ALAS II fuel senders helps provide a custom solution for any type of watercraft and ensures accurate and reliable readings even in unusual tank shapes, sizes or configurations. Our new line of cameras and monitor screens are designed to extend your monitoring capabilities and make boating safer, easier and more secure. Built to withstand the toughest marine environments, VDO LCD monitor screens can accept up to four simultaneous inputs including cameras, navigation and entertainment feeds. The cameras can be positioned fore and aft to help in docking maneuvers. They can also be used to provide visibility to multiple decks and below deck from a single location.

## World-class manufacturing

VDO Instruments are designed, built and brought to you by Continental Automotive Systems, one of the top 10 automotive suppliers in the world. From automotive tires, brakes and sensors, to fully integrated electronic components, we have automotive technology, resources and manufacturing capabilities that can only be found among the “Tier One” suppliers to the world’s leading auto manufacturers. That’s why, when it comes to gauges, VDO is in a league by itself.

Today, many gauge manufacturers only assemble their instruments. Most don’t even make their own gauge movements or sensors, which are critical to instrument accuracy. Every VDO Marine Instrument starts with one of our own patented movements, specifically designed for the requirements and performance criteria of that instrument. Each instrument is CE certified and built to withstand the harshest marine environments.

All of the VDO gauges are manufactured in our factories, which have earned highly coveted QS or TS9000 automotive quality ratings. We produce over 100,000 VDO instruments a day in these state-of-the-art facilities, and each instrument delivers the level of quality and consistency that car makers demand. With that experience, you know we can deliver the quality and performance you want and expect for your vessel’s instrumentation.

In addition to maintaining end-to-end manufacturing control of our instruments, we are one of the few companies in the world that design and manufacture our own fuel, pressure and temperature senders. We make sure that our gauges and accessories fit together and work together to deliver the most accurate readings possible while providing years of trouble free service.



1902 – Eddy Current speedometer



VDO Marine Instruments have long been the industry's choice for rugged and dependable performance, elegant design and leading-edge technology. We continue to work to deliver the innovation, functionality and durability that have earned VDO the best-in-class reputation for instrumentation worldwide – not only in the marine industry, but also in the automotive, commercial, power sports and custom vehicle markets.

Today, the VDO Marine Instrument line is the single most complete offering in the business, and the catalog you're holding represents our latest offering of world class instruments and accessories. We have an instrument solution for every type of watercraft from workboats, to pleasure craft, to luxury yachts. No other instrument supplier can cover all these categories.

We offer a wide range of instrumentation in both traditional and contemporary styles with crisp graphics, innovative designs, stunning dials and a variety of exciting bezel choices. Regardless of which gauge series you choose, you can count on the VDO tradition of excellence for rock-solid reliability, attention to detail and fit and finish.

To make your selection of instrumentation easier, we offer the options of a matched instrument and sender kit or complete kits to outfit your boat. These options are the best in the industry and will give you the biggest bang for your buck. Don't just take our word, check them out and compare.

Thank you for taking the time to get to know us better. We wish you well with your project and sincerely hope, that when it comes to instruments and sensors, you will look to VDO to satisfy your needs.

To see the most up-to-the minute VDO innovations, visit: [marine.vdo-gauges.com](http://marine.vdo-gauges.com).



Continental facilities reach worldwide, bringing you our economies of scale.

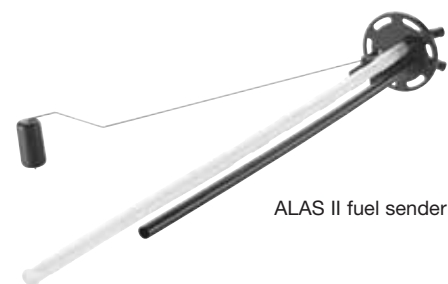

ALAS II fuel sender



## VDO – Over a century of industry milestones

- 1902 “Eddy Current” speedometer invented by Otto Schulze
- 1929 “VDO” becomes a registered trademark
- 1956 VDO invents first electronic speedometer
- 1971 VDO opens manufacturing facility in Winchester, VA
- 1984 VDO introduces through dial illumination and illuminated pointers
- 1986 VDO brings flat LCD displays to the market
- 1986 VDO introduces Blue Line, featuring the first fog free, dual lens
- 1990s VDO incorporates LED technology
- 1992 VDO brings the Vanguard series to market, featuring color changing LED illumination and Quad instruments
- 1993 VDO introduces microprocessor-controlled, stepper motor technology
- 2000s VDO delivers 120,000 instrument movements on a daily basis
- 2002 VDO Ocean Line introduces removable bezels, built in warning lights and IP67 rated water tight lenses
- 2004 VDO Ocean Link breaks ground with CAN based (digital) engine monitoring instruments
- 2007 VDO becomes a brand of Continental



VDO Blue Line Series



VDO Vanguard Series



VDO Ocean Line



VDO Instrument distribution facility, Allentown, PA



VDO Instrument distribution facility, Babenhausen, Germany

# 2012 New Products



### VDO onboard cameras and screens

Our new line of cameras and monitor screens are designed to make boating safer, easier and more secure. Cameras can be positioned fore and aft to help in docking maneuvers. They can also be used to provide visibility to multiple decks and below deck from a single location.

Built to withstand the toughest marine environments, VDO LCD monitor screens can accept up to four simultaneous inputs including cameras, navigation and entertainment feeds.

See more on page 12



### VDO Viewline Navigation

Four all new 85mm navigation instruments including Sumlog & Compass, Water Depth/Temp, Close Haul Wind Gauge and Wind Direction & Speed Gauge.

Each of these navigation instruments utilize a NMEA 0183 input signal, and can display up to 5 different readouts in the multi-function LCD display.

As with all Viewline Instruments, each features a fog free dual lens, is rated at IP67, is 12/24V compatible and features LED illumination.



### 5" Viewline Quad Gauges

Our new Viewline Multi-function gauges feature patented VDO movements, LED illumination and LED warning lights for each gauge function. All connections are made through two SpeedHarness™ plug-n-play connectors for easy hookup.



### 2 1/16" Viewline Tachometers

Now, VDO Viewline Tachometer technology is available in a compact 2 1/16" (52mm) size. These tachometers are preset from the factory and require no dip-switch setting or calibration.

### VDO GPS Speed Sender

VDO GPS Speed Sender: Incredible accuracy with no calibration.

Now, make any VDO electronic speedometer into an incredibly accurate GPS-driven Speedometer. With the VDO GPS Speed Sender, there's no calibration required. No buttons or switches to activate. Just hook up power and ground and you're ready to go.

The VDO GPS sender's small size allows a variety of easy mounting options including the back of the speedo. The sender features an LED activity status indicator and a signal loss protection circuit that continues to transmit last known speed until the GPS signal is regained.



### LED Replacement Bulbs

Colored, long life LED bulbs are designed to fit in traditional wedge based bulb sockets. In addition to adding a dash of style, these LED bulbs draw less power, last 20,000 hours or more and operate at cooler temperatures.



VDO Viewline: OEM technology. OEM quality. In each and every instrument.



1. Spin-Lok™ mounting – a VDO innovation developed to safeguard against mounting panel warping and make installation fast and easy.
2. Single PCB increases reliability and minimizes instrument depth.
3. Built-in LED warning indicators (up to 5) are programmable to OEM-specified function.
4. Single cavity connectors reduce wiring installation time.
5. Reverse polarity and over voltage protection virtually eliminate the possibility of installation failures.
6. VDO is one of the few companies in the world to design, patent and manufacture stepper motors and resistive movements.
7. Corrosion-free and flame retardant materials comply with manufacturer's latest specifications.
8. Laser welded lenses ensure the highest level of protection against water intrusion.
9. Dual domed lenses eliminate fogging – another VDO innovation.
10. LED lit pointers and "through dial lighting" minimize current consumption while optimizing nighttime viewing.
11. Detail finish ring enhances the overall appearance of finished instrument – a VDO exclusive.
12. Designed to withstand continuous 25 G vibrations and 100 G single shock, to ensure maximum reliability of each instrument.
13. Large, multifunction backlit LCD provides easy readout of programmed functions.
14. Customer installed bezels with nine style choices allow for greater styling differentiation between product lines.



VDO Spin-Lok™ mounting



Viewline Onyx with chrome round bezel



Viewline Ivory with black round bezel



Viewline Sterling with chrome triangle bezel



VDO LCD monitor screens can accept up to four simultaneous inputs including camera, navigation and entertainment feeds.\*

\*Check location regulations for use of video in motor vehicles.

### Camera Kits

Kits include display and camera as listed, with 1m connection cable per camera. Each display includes a wireless remote control. Extension cables sold separately.

Catalog Number	Description
A2C59519820	5.6" Display with Rear View Mini Camera with Parking Guide Lines
A2C59519819	7" Display with Rear View Mini Camera with Parking Guide Lines
A2C59519821	7" Quad Display with 2 Side Mount Cameras and 2 Large Rear View Cameras
A2C59519818	7" Quad Display with 2 Side Mount Cameras and 2 Small Rear View Cameras
A2C59519822	7" Quad Display with 2 Side Mount Cameras and a Rear View Mini with Parking Guide Lines



### Mini Cameras

Rear View Backup cameras offer enhanced visibility both inside and outside the vehicle

Catalog Number	Description
A2C59519794-S	Mini Camera with Parking Guide Lines
A2C59519795-S	Rear View Mini Camera

### 120° View Cameras

120° view cameras offer enhanced visibility both inside and out utilize infrared LED for enhanced nighttime visibility..

Catalog Number	Description
A2C59519790-S	120 Degree Rear View Camera Large with Sun Guard
A2C59519792-S	120 Degree Rear View Camera Large with Sun Guard and Audio Input Option
A2C59519791-S	120 Degree Rear View Camera Small with IR LED Lights

### Side Mount Cameras

120° Side View Cameras allow better visibility and maneuvering. Infrared LED's enhance nighttime viewing.

Catalog Number	Description
A2C59519793-S	120 Degree Direct Mount Side View Camera with IR LED Lights

### Camera Displays

These flexible and compact displays have multiple mounting options, and are capable of multiple viewing displays.

Catalog Number	Description
A2C59519796-S	5.6" Single Camera Display
A2C59519797-S	7" Dual View Camera Display
A2C59519798-S	7" Quad View Camera Display

### Camera Accessories

Catalog Number	Description
A2C59519799-S	16ft (5m) Extension Cable
A2C59519800-S	33ft (10m) Extension Cable
A2C59519801-S	65ft (20m) Extension Cable





Viewline Onyx with chrome triangle bezel

### Complete Instrument Kits

A2C59519563	4 Gauge Kit with Multifunction Tachometer for Outboards
A2C59519566	7 Gauge Kit for Inboards. Use with Common Marine Senders (not included)
A2C59519569	Premium 7 Gauge Kit for Inboards. Complete with VDO Senders

### 4 Gauge Kit for Outboards

- 50 MPH Pitot Speedometer
- 8,000 RPM Tachometer with Multifunction LCD
- 8-16V Voltmeter
- 30 PSI Water Pressure Gauge

### 7 Gauge Kits for Inboards

- 50 MPH Pitot Speedometer
- 6,000 RPM Tachometer
- 80 PSI Oil Pressure Gauge, Electrical
- 240°F Temperature Gauge, Electrical
- Fuel Gauge
- 8-16V Voltmeter
- Trim Gauge

Fuel, oil pressure and water temperature gauges are designed to work with common marine senders (not included)

### 7 Gauge Premium Kits:

- Same contents as 7 Gauge Kits for Inboards except:
- Substitute with 8,000 RPM Tachometer with Multi-function LCD
- Substitute with 250°F temperature gauge, electrical
- Supplied with:
  - 80 PSI oil pressure sender with low pressure warning contact
  - 250°F temperature sender
  - 221°F temperature switch
  - ALAS I fuel sender with low fuel warning contact
  - 1/2" Adapter fro Temperature Sender
  - 1/8x27 NPTF x 1/4", 3/8" and 1/2" adapter kit for pressure sender

### All Instrument Kits Feature Chrome Bezels



A2C53194641-S

### Electronic Speedometers. Use with VDO 340 786 GPS Speed Sender

Speedometers feature 1-button auto calibration and user defined speed warning. LCD features odometer, trip-odometer, voltage and clock.

Catalog Number	Description
A2C53194641-S	85mph/140kmh 5" Dial (4 3/8" (110mm) mounting) Electronic Speedometer 12/24V
A2C53194747-S	85mph/140kmh 3 3/8" (85mm) Electronic Speedometer 12/24V



A2C53194774-S

### Sumlogs with Multifunction LCD

Indicates vessel speed, odometer, depth and water temperature when used with 402-002 or 402-003 sensors. Indicates vessel speed, odometer, course and steering aid when used with Airmar GPS sensor or Airmar PB100/200 Weather Station. Can also use 340 786 GPS speed sender to display vessel speed and odometer

Catalog Number	Description
A2C53194774-S	60mph Sumlog (Speed/Depth/Temp) 3 3/8" (85mm) with Odometer, Clock and Voltmeter 12/24V.
A2C53435168-S	30kn Sumlog (Speed/Depth/Temp) 3 3/8" (85mm) with Odometer, Clock and Voltmeter 12/24V.
A2C53441682-S	12kn Sumlog (Speed/Depth/Temp) 3 3/8" (85mm) with Odometer, Clock and Voltmeter 12/24V.



A2C59513642-S

### Pitot Speedometers

Catalog Number	Description
A2C59513642-S	50 MPH 3 3/8" (85mm) Pitot Speedometer 12V
A2C59513645-S	80 MPH 3 3/8" (85mm) Pitot Speedometer 12V

### Pitot Speedometer and Fuel Combination Gauges

Pitot Speedometer and fuel combination gauge compatible with standard VDO 10-180 ohm fuel senders. Gauge and sender kits include VDO ALAS I fuel sender, pitot sender and tubing.

Catalog Number	Description	See Sender Table
A2C53405006-K	30MPH Pitot Speedometer & Fuel Gauge Combo Kit. 5" Dial (4 3/8" (110mm) mounting) 12V. Includes VDO Fuel Sender, Pitot Sender and Tubing.	
A2C53405006-S	30MPH Pitot Speedometer & Fuel Gauge Combo. 5" Dial (4 3/8" (110mm) mounting) 12V. Pitot Sender & VDO Fuel Sender Not Included.	ALAS I & II
A2C53405008-K	50MPH Pitot Speedometer & Fuel Gauge Combo Kit. 5" Dial (4 3/8" (110mm) mounting) 12V. Includes VDO Fuel Sender, Pitot Sender and Tubing.	
A2C53405008-S	50MPH Pitot Speedometer & Fuel Gauge Combo. 5" Dial (4 3/8" (110mm) mounting) 12V. Pitot Sender & VDO Fuel Sender Not Included.	ALAS I & II
A2C53405010-K	80MPH Pitot Speedometer & Fuel Gauge Combo Kit. 5" Dial (4 3/8" (110mm) mounting) 12V. Includes VDO Fuel Sender, Pitot Sender and Tubing.	
A2C53405010-S	80MPH Pitot Speedometer & Fuel Gauge Combo. 5" Dial (4 3/8" (110mm) mounting) 12V. Pitot Sender & VDO Fuel Sender Not Included.	ALAS I & II

### Sailing Navigation

Wind Speed/Direction Gauge shows 180° of wind direction to Port or Stbd, apparent wind speed, air pressure, air temperature, time and system voltage. Close Hauled gauge shows wind direction within 60° of Port or Stbd. Requires Airmar PB100 or PB200 Weather Station.

Catalog Number	Description
A2C53428540-S	Wind Speed & Direction Gauge. 3 3/8" (85mm) 12/24V
A2C53435260-S	Close Hauled Gauge. 3 3/8" (85mm) 12/24V

### Depth Gauge

Displays water depth on the dial. Water temperature, clock and system voltage are shown in the LCD window. Use with VDO 402-002, 402-003 or Airmar DT 800 sensors.

Catalog Number	Description
A2C53428506-S	Depth Gauge with Water Temp & Clock. 3 3/8" (85mm) 12/24V

### Pre-Programmable Tachometers

These tachometers are preset from the factory and require no dip-switch setting or calibration.

Catalog Number	Description
A2C53210895-S-2P	8,000 RPM 2 1/16" (52mm) Tachometer. For 4 Cylinder Gas Engines 12/24V (2 Pulse/Rev Signal)
A2C53210895-S-3P	8,000 RPM 2 1/16" (52mm) Tachometer. For 6 Cylinder Gas Engines 12/24V (3 Pulse/Rev Signal)
A2C53210895-S-4P	8,000 RPM 2 1/16" (52mm) Tachometer. For 8 Cylinder Gas Engines 12/24V (4 Pulse/Rev Signal)
A2C53210899-S-2P	6,000 RPM 2 1/16" (52mm) Tachometer. For 4 Cylinder Gas Engines 12/24V (2 Pulse/Rev Signal)
A2C53210899-S-3P	6,000 RPM 2 1/16" (52mm) Tachometer. For 6 Cylinder Gas Engines 12/24V (3 Pulse/Rev Signal)
A2C53210899-S-4P	6,000 RPM 2 1/16" (52mm) Tachometer. For 8 Cylinder Gas Engines 12/24V (4 Pulse/Rev Signal)



A2C53210895-S



A2C32561900-S

### Marine Programmable Tachometers with Multifunction LCD

Specially designed for marine applications. Includes warning tell-tales for bilge pump operation, bilge blower operation, bow light on, anchor light on and check engine. Programmable tachometers features: User defined rev. limit warning, LCD display for total hours, resettable hours, voltage and clock. Accepts signal inputs from electronic controlled ignitions with tachometer output terminal, standard coil ignition, alternator signal and 12V square wave applications.

Catalog Number	Description
A2C32561900-S	6,000 RPM 3 3/8" (85mm) Marine Tachometer with 2 Hourmeters, Clock and Voltmeter 12/24V





A2C53194789-S

### Programmable Tachometers with Multifunction LCD

Programmable tachometers feature: User defined rev. limit warning, LCD display for total hours, resettable hours, voltage and clock. Accepts signal inputs from electronic controlled ignitions with tachometer output terminal, standard coil ignition, alternator signal and 12V square wave applications.

Catalog Number	Description
A2C53194590-S	8,000 RPM 5" Dial (4 3/8" (110mm) mounting) Tachometer with 2 Hourmeters, Clock and Voltmeter 12/24V
A2C53194593-S	6,000 RPM 5" Dial (4 3/8" (110mm) mounting) Tachometer with 2 Hourmeters, Clock and Voltmeter 12/24V
A2C53194596-S	4,000 RPM 5" Dial (4 3/8" (110mm) mounting) Tachometer with 2 Hourmeters, Clock and Voltmeter 12/24V
A2C53194789-S	3,000 RPM 3 3/8" (85mm) Tachometer with 2 Hourmeters, Clock and Voltmeter 12/24V
A2C53194863-S	4,000 RPM 3 3/8" (85mm) Tachometer with 2 Hourmeters, Clock and Voltmeter 12/24V
A2C53194872-S	6,000 RPM 3 3/8" (85mm) Tachometer with 2 Hourmeters, Clock and Voltmeter 12/24V
A2C53194885-S	8,000 RPM 3 3/8" (85mm) Tachometer with 2 Hourmeters, Clock and Voltmeter 12/24V



A2C53218716-S

### Programmable Tachometers

Programmable tachometers accept signal inputs from 2,4,6,8,10,12 & 16 cylinder standard coil ignition, alternator signal and 12V square wave applications. User defined rev. limit warning and programming can be done using Viewline programming software (available separately).

Catalog Number	Description
A2C53218711-S	3,000 RPM 4 3/8" (110mm) Tachometer 12/24V
A2C53218712-S	4,000 RPM 4 3/8" (110mm) Tachometer 12/24V
A2C53218713-S	7,000 RPM 4 3/8" (110mm) Tachometer 12/24V
A2C53218716-S	3,000 RPM 3 3/8" (85mm) Tachometer 12/24V
A2C53218722-S	4,000 RPM 3 3/8" (85mm) Tachometer 12/24V
A2C53218726-S	6,000 RPM 3 3/8" (85mm) Tachometer 12/24V
A2C53408405-S	8,000 RPM 3 3/8" (85mm) Tachometer 12/24V

### Tachometer and Trim Combination Gauges

Programmable tachometers compatible with most outboard or sterndrives that use either ignition coil, alternator signal or ECM signal outputs. Trim gauge compatibility as listed below.

Catalog Number	Description
A2C53371936-S	6,000 RPM Tachometer & Trim Combo Gauge, 5" Dial (4 3/8" (110mm) mounting) 12V. Trim Compatible with Mercury/Volvo/Yamaha 2001+
A2C53371939-S	7,000 RPM Tachometer & Trim Combo Gauge, 5" Dial (4 3/8" (110mm) mounting) 12V. Trim Compatible with Mercury/Volvo/Yamaha 2001+
A2C53371942-S	8,000 RPM Tachometer & Trim Combo Gauge, 5" Dial (4 3/8" (110mm) mounting) 12V. Trim Compatible with Mercury/Volvo/Yamaha 2001+



A2C53194780-S

### Engine Synchronizers

Engine synchronizers work with gas engines via dip-switch settings. Diesel engines require use of programming software available separately.

Catalog Number	Description
A2C53194780-S	Synchronizer 3 3/8" (85mm) 12/24V



A2C81561900-S

### Quad Gauges

Quad gauges display fuel level, water temperature, oil pressure and voltage.

Catalog Number	Description	See Sender Table
A2C53371945-S	Quad Gauge 8-16Volt/5bar/120°C/O-1/1 Fuel. 5" Dial (4 3/8" (110mm) mounting) 12V. Use with VDO senders.	A/1/ALAS
A2C81561900-S	Quad Gauge 8-16V/80 PSI/250°F/E-F Fuel. 5" Dial (4 3/8" (110mm) Mounting) 12V. Use with VDO senders.	A/1/ALAS
A2C53371957-S	Quad Gauge 8-16Volt/L-H Oil/C-H Temp/E-F Fuel. 5" Dial (4 3/8" (110mm) mounting) 12V. Use with common marine senders.	

### Fluid Temperature Gauge and Sender Kits, Electrical, 2 1/16" (52mm) Dia

Catalog Number	Description
A2C53191360-K1	250°F Water Temperature Gauge 12V with VDO Sender and US Thread Adapters
A2C53413355-K1	250°F Water Temperature Gauge 12/24V with VDO Sender and US Thread Adapters
A2C53191360-K2	250°F Water Temperature Gauge 12V with VDO Sender and Metric Thread Adapters
A2C53413355-K2	250°F Water Temperature Gauge 12/24V with VDO Sender and Metric Thread Adapters
A2C53191722-K1	250°F/120°C Water Temperature Gauge 12V with VDO Sender and US Thread Adapters
A2C53413386-K1	250°F/120°C Water Temperature Gauge 12/24V with VDO Sender and US Thread Adapters
A2C53413386-K2	250°F/120°C Water Temperature Gauge 12/24V with VDO Sender and Metric Thread Adapters



A2C53191359-S

### Fluid Temperature Gauges, Electrical, 2 1/16" (52mm) Dia

Catalog Number	Description	See Sender Table
A2C53413405-S	300°F /150°C Oil Temperature Gauge 12/24V, Use with VDO Sender	B
A2C53191362-S	400°F Temperature Gauge 12V, Use with VDO Sender	C
A2C53418135-S	400°F Temperature Gauge 12/24V, Use with VDO Sender	C
A2C53191359-S	240°F Water Temperature Gauge 12V, Use with US Sender	D
A2C53413351-S	240°F Water Temperature Gauge 12/24V, Use with US Sender	D
A2C53191360-S	250°F Water Temperature Gauge 12V, Use with VDO Sender	A
A2C53413355-S	250°F Water Temperature Gauge 12/24V, Use with VDO Sender	A
A2C53413386-S	250°F/120°C Water Temperature Gauge 12/24V, Use with VDO Sender	A



A2C53210847-S

### Outside Temperature Gauges, Electrical, 2 1/16" (52mm) Dia

Catalog Number	Description	See Sender Table
A2C53210847-K	-10/+120°F Outside Temperature Gauge 12/24V with VDO Sender	
A2C53210847-S	-10/+120°F Outside Temperature Gauge 12/24V, Requires Sender 323 112	E



A2C53210907-S

### Pyrometer, Electrical, 2 1/16" (52mm) Dia

Catalog Number	Description	See Sender Table
A2C53210907-K	1650°F Pyrometer 12/24V with VDO Sender	
A2C53210907-S	1650°F Pyrometer 12/24V, Requires 326 001 Sender	E

### Oil Pressure Gauge and Sender Kits, Electrical, 2 1/16" (52mm) Dia

Catalog Number	Description
A2C53412998-K1	80 PSI Oil Pressure Gauge 12/24V with VDO Sender and US Thread Adapters
A2C53412998-K2	80 PSI Oil Pressure Gauge 12/24V with VDO Sender and Metric Thread Adapters
A2C53191733-K1	80 PSI/5 bar Gauge 12V & Sender Kit with US Thread Adapters
A2C53413151-K1	80 PSI/5 bar Oil Pressure Gauge 12/24V with VDO Sender and US Thread Adapters
A2C53191733-K2	80 PSI/5 bar Gauge 12V & Sender Kit with Metric Thread Adapters
A2C53413151-K2	80 PSI/5 bar Oil Pressure Gauge 12/24V with VDO Sender and Metric Thread Adapters
A2C53413141-K1	150 PSI/10 bar Gauge 12/24V & Sender Kit with US Thread Adapters
A2C53413141-K2	150 PSI/10 bar Gauge 12/24V & Sender Kit with Metric Thread Adapters
A2C53413157-K1	150 PSI/10 bar Gauge 12/24V & Sender Kit with US Thread Adapters, ISO Symbol
A2C53413157-K2	150 PSI/10 bar Gauge 12/24V & Sender Kit with Metric Thread Adapters, ISO Symbol



A2C53412999-S

### Oil Pressure Gauges, Electrical, 2 1/16" (52mm) Dia

Catalog Number	Description	See Sender Table
A2C53412998-S	80 PSI Oil Pressure Gauge 12/24V, Use with VDO Sender	1
A2C53191384-S	80 PSI Oil Pressure Gauge 12V, Use with US Sender	2
A2C53412999-S	80 PSI Oil Pressure Gauge 12/24V, Use with US Sender	2
A2C53191402-S	80 PSI/5 bar Oil Pressure Gauge 12V, Use with US Sender	
A2C53413006-S	80 PSI/5 bar Oil Pressure Gauge 12/24V, Use with US Sender	
A2C53191733-S	80 PSI/5 bar Oil Pressure Gauge 12V, Use with VDO Sender	1

**Oil Pressure Gauges, Electrical, 2 1/16" (52mm) Dia**

Catalog Number	Description	See Sender Table
A2C53413151-S	80 PSI/5 bar Oil Pressure Gauge 12/24V, Use with VDO Sender	1
A2C53413154-S	100 PSI/7 bar Oil Pressure Gauge 12/24V, Use with US Sender	4
A2C53191735-S	150 PSI/10 bar Oil Pressure Gauge 12V, Use with US Sender	
A2C53413156-S	150 PSI/10 bar Oil Pressure Gauge 12/24V, Use with US Sender	
A2C53413141-S	150 PSI/10 bar Oil Pressure Gauge 12/24V, Use with VDO Sender	5
A2C53417222-S	400 PSI/25 bar Gear Pressure Gauge 12/24V, Use with VDO Sender	7
A2C53413157-S	150 PSI/10 bar Oil Pressure Gauge 12/24V, Use with VDO Sender, ISO Symbol	5

**Turbo & Boost Gauges, Electrical, 2 1/16" (52mm) Dia**

Catalog Number	Description	See Sender Table
A2C53191728-S	2 bar/28 PSI Turbo Gauge 12V, Use with VDO Sender	8
A2C53417219-S	2 bar/28 PSI Turbo Gauge 12/24V, Use with VDO Sender	8

**Water Pressure Gauges, Mechanical, 2 1/16" (52mm) Dia**

Catalog Number	Description
A2C59513648-S	30 PSI Water Pressure Gauge 12V
A2C59513651-S	40 PSI Water Pressure Gauge 12V

**Power Trim, 2 1/16" (52mm) Dia**

Catalog Number	Description
A2C53417260-S	Trim Gauge 12/24V, Mercury/Volvo Penta/2001+ Yamaha

**Rudder Angle Indicator**

Catalog Number	Description
A2C53192577-S	Rudder Angle Indicator 2 1/16" (52mm) 12V, Use with VDO Sender
A2C53417228-S	Rudder Angle Indicator 2 1/16" (52mm) 12/24V, Use with VDO Sender
A2C53194714-S	Rudder Angle Indicator 3 9/16" (85mm) 12/24V, Use with VDO Sender

**Water Level Gauges, Electrical, 2 1/16" (52mm) Dia**

Catalog Number	Description	See Sender Table
A2C53192574-S	Freshwater Gauge, 12V, Use with VDO 10-180 Ohm Sender	Water Level Senders
A2C53418137-S	Freshwater Gauge 12/24V, Use with VDO 10-180 Ohm Sender	Water Level Senders
A2C53210834-S	Wastewater Gauge, 12/24V, Use with VDO Capacitive Sender	Water Level Senders
A2C53210954-S	Freshwater Gauge, 12/24V, Use with VDO Capacitive Sender	Water Level Senders
A2C31401700-S	Freshwater Gauge, 12/24V, Use with VDO Capacitive Sender	Water Level Senders

**Fuel Level Gauge and Sender Kits, 2 1/16" (52mm) Dia**

Catalog Number	Description
A2C53191757-K	Fuel Gauge 12V and ALAS I Fuel Sender Kit
A2C53412987-K	Fuel Gauge 12/24V and ALAS I Fuel Sender Kit



A2C53191728-S



A2C53192577-S



A2C53192574-S



A2C53191757-K



A2C53191757-S



A2C53191766-S



A2C53210957-K

**Fuel Level Gauges, Electrical, 2 1/16" (52mm) Dia**

Catalog Number	Description	See Sender Table
A2C53191757-S	Fuel Gauge 12V, Use with 3-180 Ohm Sender	ALAS I & II
A2C53412987-S	Fuel Gauge 12/24V, Use with 3-180 Ohm Sender	ALAS I & II
A2C53191758-S	Fuel Gauge 12V, Use with 240-33 Ohm Sender	ALAS I & II
A2C53412988-S	Fuel Gauge 12/24V, Use with 240-33 Ohm Sender	ALAS I & II
A2C53191760-S	Fuel Gauge 12V, Use with VDO Tube Type Sender	Tube Type Fuel
A2C53412990-S	Fuel Gauge 12/24V, Use with VDO Tube Type Sender	Tube Type Fuel

**Ammeter and Shunt Kits, 2 1/16" (52mm) dia**

Catalog Number	Description
A2C53210957-K	150A Ammeter, Includes Required Shunt
A2C53210959-K	60A Ammeter, Includes Required Shunt
A2C53210973-K	100A Ammeter, Includes Required Shunt
A2C53211039-K	30A Ammeter, Includes Required Shunt

**Ammeters (external shunt required), 2 1/16" (52mm) Dia**

Catalog Number	Description
A2C53210957-S	150A Ammeter 12/24V, Requires External 60mv Shunt
A2C53210959-S	60A Ammeter 12/24V, Requires External 60mv Shunt
A2C53210973-S	100A Ammeter 12/24V, Requires External 60mv Shunt
A2C53211039-S	30A Ammeter 12/24V, Requires External 60mv Shunt

**Voltmeters, 2 1/16" (52mm) Dia**

Catalog Number	Description
A2C53191766-S	12V Voltmeter
A2C53191767-S	24V Voltmeter

**Hourmeters, 2 1/16" (52mm) Dia**

Catalog Number	Description
A2C59510876-S	Hourmeter 12/24V

**Clocks, Electrical, 2 1/16" (52mm) Dia**

Catalog Number	Description
A2C53321687-S	Analog Clock 12V
A2C53321689-S	Analog Clock 24V



Viewline Onyx with white round bezel



Viewline Onyx with black triangle bezel





Viewline Ivory with chrome triangle bezel

### Complete Instrument Kits

A2C59519564	4 Gauge Kit with Multifunction Tachometer for Outboards
A2C59519567	7 Gauge Kit for Inboards. Use with Common Marine Senders (not included)
A2C59519570	Premium 7 Gauge Kit for Inboards. Complete with VDO Senders

### 4 Gauge Kit for Outboards

- 50 MPH Pitot Speedometer
- 8,000 RPM Tachometer with Multifunction LCD
- 8-16V Voltmeter
- 30 PSI Water Pressure Gauge

### 7 Gauge Kits for Inboards

- 50 MPH Pitot Speedometer
- 6,000 RPM Tachometer
- 80 PSI Oil Pressure Gauge, Electrical.
- 240°F Temperature Gauge, Electrical
- Fuel Gauge
- 8-16V Voltmeter
- Trim Gauge

Fuel, oil pressure and water temperature gauges are designed to work with common marine senders (not included)

### 7 Gauge Premium Kits:

- Same contents as 7 Gauge Kits for Inboards except:
- Substitute with 8,000 RPM Tachometer with Multi-function LCD
- Substitute with 250°F temperature gauge, electrical
- Supplied with:
  - 80 PSI oil pressure sender with low pressure warning contact
  - 250°F temperature sender
  - 221°F temperature switch
  - ALAS I fuel sender with low fuel warning contact
  - 1/2" Adapter fro Temperature Sender
  - 1/8x27 NPTF x 1/4", 3/8" and 1/2" adapter kit for pressure sender

### All Instrument Kits Feature Chrome Bezels



A2C53194748-S

### Electronic Speedometers. Use with VDO 340 786 GPS Speed Sender

Speedometers feature 1-button auto calibration and user defined speed warning. LCD features odometer, trip-odometer, voltage and clock.

Catalog Number	Description
A2C53194748-S	85mph/140kmh 3 9/16" (85mm) Electronic Speedometer 12/24V

### Sumlogs with Multifunction LCD

Indicates vessel speed, odometer, depth and water temperature when used with 402-002 or 402-003 sensors. Indicates vessel speed, odometer, course and steering aid when used with Airmar GPS sensor or Airmar PB100/200 Weather Station. Can also use 340 786 GPS speed sender to display vessel speed and odometer

Catalog Number	Description
A2C53194776-S	60mph Sumlog (Speed/Depth/Temp) 3 9/16" (85mm) with Odometer, Clock and Voltmeter 12/24V.
A2C53435180-S	30kn Sumlog (Speed/Depth/Temp) 3 9/16" (85mm) with Odometer, Clock and Voltmeter 12/24V.
A2C53441683-S	12kn Sumlog (Speed/Depth/Temp) 3 9/16" (85mm) with Odometer, Clock and Voltmeter 12/24V.



A2C53194776-S

### Pitot Speedometers

Catalog Number	Description
A2C59513643-S	50 MPH 3 9/16" (85mm) Pitot Speedometer 12V
A2C59513646-S	80 MPH 3 9/16" (85mm) Pitot Speedometer 12V



A2C59513643-S

### Pitot Speedometer and Fuel Combination Gauges

Pitot Speedometer and fuel combination gauge compatible with standard VDO 10-180 ohm fuel senders. Gauge and sender kits include VDO ALAS I fuel sender, pitot sender and tubing.

Catalog Number	Description	See Sender Table
A2C53405005-K	30MPH Pitot Speedometer & Fuel Gauge Combo Kit. 5" Dial (4 9/16" (110mm) Mounting) 12V. Includes VDO Fuel Sender, Pitot Sender and Tubing.	
A2C53405005-S	30MPH Pitot Speedometer & Fuel Gauge Combo. 5" Dial (4 9/16" (110mm) mounting) 12V. Pitot Sender & VDO Fuel Sender Not Included.	ALAS I & II
A2C53405007-K	50MPH Pitot Speedometer & Fuel Gauge Combo Kit. 5" Dial (4 9/16" (110mm) mounting) 12V. Includes VDO Fuel Sender, Pitot Sender and Tubing.	
A2C53405007-S	50MPH Pitot Speedometer & Fuel Gauge Combo. 5" Dial (4 9/16" (110mm) mounting) 12V. Pitot Sender & VDO Fuel Sender Not Included.	ALAS I & II
A2C53405009-K	80MPH Pitot Speedometer & Fuel Gauge Combo Kit. 5" Dial (4 9/16" (110mm) mounting) 12V. Includes VDO Fuel Sender, Pitot Sender and Tubing.	
A2C53405009-S	80MPH Pitot Speedometer & Fuel Gauge Combo. 5" Dial (4 9/16" (110mm) mounting) 12V. Pitot Sender & VDO Fuel Sender Not Included.	ALAS I & II

### Sailing Navigation

Wind Speed/Direction Gauge shows 180° of wind direction to Port or Stbd, apparent wind speed, air pressure, air temperature, time and system voltage. Close Hauled gauge shows wind direction within 60° of Port or Stbd. Requires Airmar PB100 or PB200 Weather Station.

Catalog Number	Description
A2C53428541-S	Wind Speed & Direction Gauge. 3 9/16" (85mm) 12/24V
A2C53435239-S	Close Hauled Gauge. 3 9/16" (85mm) 12/24V

### Depth Gauge

Displays water depth on the dial. Water temperature, clock and system voltage are shown in the LCD window. Use with VDO 402-002, 402-003 or Airmar DT 800 sensors.

Catalog Number	Description
A2C53428507-S	Depth Gauge with Water Temp & Clock. 3 9/16" (85mm) 12/24V

### Pre-Programmable Tachometers

These tachometers are preset from the factory and require no dip-switch setting or calibration.

Catalog Number	Description
A2C53210892-S-2P	8,000 RPM 2 1/16" (52mm) Tachometer. For 4 Cylinder Gas Engines 12/24V (2 Pulse/Rev Signal)
A2C53210892-S-3P	8,000 RPM 2 1/16" (52mm) Tachometer. For 6 Cylinder Gas Engines 12/24V (3 Pulse/Rev Signal)
A2C53210892-S-4P	8,000 RPM 2 1/16" (52mm) Tachometer. For 8 Cylinder Gas Engines 12/24V (4 Pulse/Rev Signal)
A2C53210897-S-2P	6,000 RPM 2 1/16" (52mm) Tachometer. For 4 Cylinder Gas Engines 12/24V (2 Pulse/Rev Signal)
A2C53210897-S-3P	6,000 RPM 2 1/16" (52mm) Tachometer. For 6 Cylinder Gas Engines 12/24V (3 Pulse/Rev Signal)
A2C53210897-S-4P	6,000 RPM 2 1/16" (52mm) Tachometer. For 8 Cylinder Gas Engines 12/24V (4 Pulse/Rev Signal)



A2C53210892-S-2P

### Marine Programmable Tachometers with Multifunction LCD

Specially designed for marine applications. Includes warning tell-tales for bilge pump operation, bilge blower operation, bow light on, anchor light on and check engine. Programmable tachometers features: User defined rev. limit warning, LCD display for total hours, resettable hours, voltage and clock. Accepts signal inputs from electronic controlled ignitions with tachometer output terminal, standard coil ignition, alternator signal and 12V square wave applications.

Catalog Number	Description
A2C32562100-S	6,000 RPM 3 9/16" (85mm) Marine Tachometer with 2 Hourmeters, Clock and Voltmeter 12/24V



A2C32562100-S

### Programmable Tachometers with Multifunction LCD

Programmable tachometers feature: User defined rev. limit warning, LCD display for total hours, resettable hours, voltage and clock. Accepts signal inputs from electronic controlled ignitions with tachometer output terminal, standard coil ignition, alternator signal and 12V square wave applications.

Catalog Number	Description
A2C53194791-S	3,000 RPM 3 9/16" (85mm) Tachometer with 2 Hourmeters, Clock and Voltmeter 12/24V
A2C53194865-S	4,000 RPM 3 9/16" (85mm) Tachometer with 2 Hourmeters, Clock and Voltmeter 12/24V
A2C53194875-S	6,000 RPM 3 9/16" (85mm) Tachometer with 2 Hourmeters, Clock and Voltmeter 12/24V
A2C53194887-S	8,000 RPM 3 9/16" (85mm) Tachometer with 2 Hourmeters, Clock and Voltmeter 12/24V



A2C53194791-S

See page 48 for speedometer senders

For technical specifications and dimensions, please visit our website at [www.vdo.com/usa](http://www.vdo.com/usa)

See page 48 for tachometer senders, See page 51-56 for fuel & water level senders

For technical specifications and dimensions, please visit our website at [www.vdo.com/usa](http://www.vdo.com/usa)



A2C53218718-S

### Programmable Tachometers

Programmable tachometers accept signal inputs from 2,4,6,8,10,12 & 16 cylinder standard coil ignition, alternator signal and 12V square wave applications. User defined rev. limit warning and programming can be done using Viewline programming software (available separately).

Catalog Number	Description
A2C53218718-S	3,000 RPM 3 9/16" (85mm) Tachometer 12/24V
A2C53218724-S	4,000 RPM 3 9/16" (85mm) Tachometer 12/24V
A2C53218727-S	6,000 RPM 3 9/16" (85mm) Tachometer 12/24V
A2C53408441-S	8,000 RPM 3 9/16" (85mm) Tachometer 12/24V

### Tachometer and Trim Combination Gauges

Programmable tachometers compatible with most outboard or sterndrives that use either ignition coil, alternator signal or ECM signal outputs. Trim gauge compatibility as listed below.

Catalog Number	Description
A2C53371937-S	6,000 RPM Tachometer & Trim Combo Gauge, 5" Dial (4 9/16" (110mm) mounting) 12V. Trim Compatible with Mercury/Volvo/Yamaha 2001+
A2C53371940-S	7,000 RPM Tachometer & Trim Combo Gauge, 5" Dial (4 9/16" (110mm) mounting) 12V. Trim Compatible with Mercury/Volvo/Yamaha 2001+
A2C53371943-S	8,000 RPM Tachometer & Trim Combo Gauge, 5" Dial (4 9/16" (110mm) mounting) 12V. Trim Compatible with Mercury/Volvo/Yamaha 2001+



A2C53194781-S

### Engine Synchronizers

Engine synchronizers work with gas engines via dip-switch settings. Diesel engines require use of programming software available separately.

Catalog Number	Description
A2C53194781-S	Synchronizer 3 9/16" (85mm) 12/24V

### Quad Gauges

Quad gauges display fuel level, water temperature, oil pressure and voltage.



A2C81562100-S

Catalog Number	Description	See Sender Table
A2C53371946-S	Quad Gauge 8-16V/5bar/120°C/6-1/1 Fuel. 5" Dial (4 9/16" (110mm) mounting) 12V. Use with VDO senders.	A/1/ALAS
A2C81562100-S	Quad Gauge 8-16V/80 PSI/250°F /E-F Fuel. 5" Dial (4 9/16" (110mm) Mounting) 12V. Use with VDO senders.	A/1/ALAS
A2C53371958-S	Quad Gauge 8-16V/L-H Oil /C-H Temp/E-F Fuel. 5" Dial (4 9/16" (110mm) mounting) 12V. Use with common marine senders.	

### Fluid Temperature Gauge and Sender Kits, Electrical, 2 1/16" (52mm) Dia

Catalog Number	Description	See Sender Table
A2C53191370-K2	250°F Water Temperature Gauge 12V with VDO Sender and Metric Thread Adapters	
A2C53413384-K2	250°F Water Temperature Gauge 12/24V with VDO Sender and Metric Thread Adapters	
A2C53191726-K2	250°F/120°C Water Temperature Gauge 12V & Sender Kit with Metric Thread Adapters	
A2C53413388-K2	250°F/120°C Water Temperature Gauge 12/24V & Sender Kit with Metric Thread Adapters	
A2C53191370-K1	250°F Water Temperature Gauge 12V with VDO Sender and US Thread Adapters	D
A2C53413384-K1	250°F Water Temperature Gauge 12/24V with VDO Sender and US Thread Adapters	
A2C53191726-K1	250°F/120°C Water Temperature Gauge 12V & Sender Kit with US Thread Adapters	
A2C53413388-K1	250°F/120°C Water Temperature Gauge 12/24V & Sender Kit with US Thread Adapters	

### Fluid Temperature Gauges, Electrical, 2 1/16" (52mm) Dia

Catalog Number	Description	See Sender Table
A2C53191727-S	300°F /150°C Oil Temperature Gauge 12V, Use with VDO Sender	B
A2C53413407-S	300°F /150°C Oil Temperature Gauge 12/24V, Use with VDO Sender	B
A2C53191369-S	240°F Water Temperature Gauge 12V, Use with US Sender	
A2C53413383-S	240°F Water Temperature Gauge 12/24V, Use with US Sender	D
A2C53191370-S	250°F Water Temperature Gauge 12V, Use with VDO Sender	A



A2C53191727-S

### Fluid Temperature Gauges, Electrical, 2 1/16" (52mm) Dia

Catalog Number	Description	See Sender Table
A2C53413384-S	250°F Water Temperature Gauge 12/24V, Use with VDO Sender	A
A2C53191726-S	250°F/120°C Water Temperature Gauge 12V, Use with VDO Sender	A
A2C53413388-S	250°F/120°C Water Temperature Gauge 12/24V, Use with VDO Sender	A



A2C53210844-S

### Outside Temperature Gauges, Electrical, 2 1/16" (52mm) Dia

Catalog Number	Description	See Sender Table
A2C53210844-K	-10/+120°F Outside Temperature Gauge 12/24V with VDO Sender	
A2C53210844-S	-10/+120°F Outside Temperature Gauge 12/24V, Requires Sender 323 112	E

### Pyrometer, Electrical, 2 1/16" (52mm) Dia

Catalog Number	Description	See Sender Table
A2C53210905-K	1650°F Pyrometer 12/24V with VDO Sender	
A2C53210905-S	1650°F Pyrometer 12/24V, Requires 326 001 Sender	E



A2C53210905-S

### Oil Pressure Gauge and Sender Kits, Electrical, 2 1/16" (52mm) Dia

Catalog Number	Description
A2C53191419-K1	80 PSI Oil Pressure Gauge 12V with VDO Sender and US Thread Adapters
A2C53413136-K1	80 PSI Oil Pressure Gauge 12/24V with VDO Sender and US Thread Adapters
A2C53191419-K2	80 PSI Oil Pressure Gauge 12V with VDO Sender and Metric Thread Adapters
A2C53413136-K2	80 PSI Oil Pressure Gauge 12/24V with VDO Sender and Metric Thread Adapters
A2C53191745-K1	80 PSI/5 bar Gauge 12V & Sender Kit with US Thread Adapters
A2C53413289-K1	80 PSI/5 bar Gauge 12/24V & Sender Kit with US Thread Adapters
A2C53191745-K2	80 PSI/5 bar Gauge 12V & Sender Kit with Metric Thread Adapters
A2C53413289-K2	80 PSI/5 bar Gauge 12/24V & Sender Kit with Metric Thread Adapters
A2C53191748-K1	150 PSI/10 bar Gauge 12V & Sender Kit with US Thread Adapters
A2C53413312-K1	150 PSI/10 bar Gauge 12/24V & Sender Kit with US Thread Adapters
A2C53191748-K2	150 PSI/10 bar Gauge 12V & Sender Kit with Metric Thread Adapters
A2C53413312-K2	150 PSI/10 bar Gauge 12/24V & Sender Kit with Metric Thread Adapters



A2C53191419-K1

### Oil Pressure Gauges, Electrical, 2 1/16" (52mm) Dia

Catalog Number	Description	See Sender Table
A2C53191419-S	80 PSI Oil Pressure Gauge 12V, Use with VDO Sender	1
A2C53413136-S	80 PSI Oil Pressure Gauge 12/24V, Use with VDO Sender	1
A2C53191744-S	80 PSI/5 bar Oil Pressure Gauge 12V, Use with US Ohm Sender	2
A2C53413288-S	80 PSI/5 bar Oil Pressure Gauge 12/24V, Use with US Sender	2
A2C53191745-S	80 PSI/5 bar Oil Pressure Gauge 12V, Use with VDO Sender	1
A2C53413289-S	80 PSI/5 bar Oil Pressure Gauge 12/24V, Use with VDO Sender	1
A2C53191746-S	100 PSI/7 bar Oil Pressure Gauge 12V, Use with US Sender	4
A2C53413310-S	100 PSI/7 bar Oil Pressure Gauge 12/24V, Use with US Sender	4
A2C53191747-S	150 PSI/10 bar Oil Pressure Gauge 12V, Use with US Sender	
A2C53413311-S	150 PSI/10 bar Oil Pressure Gauge 12/24V, Use with US Sender	
A2C53191748-S	150 PSI/10 bar Oil Pressure Gauge 12V, Use with VDO Sender	5
A2C53413312-S	150 PSI/10 bar Oil Pressure Gauge 12/24V, Use with VDO Sender	5
A2C53191750-S	400 PSI/25 bar Gear Pressure Gauge 12V, Use with VDO Sender	7
A2C53417226-S	400 PSI/25 bar Gear Pressure Gauge 12/24V, Use with VDO Sender	7



A2C53191750-S





A2C53191739-S

**Turbo & Boost Gauges, Electrical, 2 1/16" (52mm) Dia**

Catalog Number	Description	See Sender Table
A2C53191739-S	2 bar Turbo Gauge 12V, Use with VDO Sender	8
A2C53417223-S	2 bar Turbo Gauge 12/24V, Use with VDO Sender	8

**Water Pressure Gauges, Mechanical, 2 1/16" (52mm) Dia**

Catalog Number	Description
A2C59513649-S	30 PSI Water Pressure Gauge 12V
A2C59513652-S	40 PSI Water Pressure Gauge 12V

**Power Trim, 2 1/16" (52mm) Dia**

Catalog Number	Description
A2C53417261-S	Trim Gauge 12/24V, Mercury/Volvo Penta/2001+ Yamaha



A2C53192578-S

**Rudder Angle Indicator**

Catalog Number	Description
A2C53192578-S	Rudder Angle Indicator 2 1/16" (52mm) 12V, Use with VDO Sender
A2C53417229-S	Rudder Angle Indicator 2 1/16" (52mm) 12/24V, Use with VDO Sender
A2C53194715-S	Rudder Angle Indicator 3 9/16" (85mm) 12/24V, Use with VDO Sender



A2C53192576-S

**Water Level Gauges, Electrical, 2 1/16" (52mm) Dia**

Catalog Number	Description	See Sender Table
A2C53192576-S	Freshwater Gauge, 12V, Use with VDO 10-180 Ohm Sender	Water Level Senders
A2C53418382-S	Freshwater Gauge 12/24V, Use with VDO Sender	Water Level Senders
A2C53210833-S	Wastewater Gauge, 12/24V, Use with VDO Capacitive Sender	Water Level Senders
A2C53210953-S	Freshwater Gauge, 12/24V, Use with VDO Capacitive Sender	Water Level Senders
A2C31402000-S	Freshwater Gauge, 12/24V, Use with VDO Capacitive Sender	Water Level Senders

**Fuel Level Gauge and Sender Kits, 2 1/16" (52mm) Dia**

Catalog Number	Description
A2C53191761-K	Fuel Gauge 12V and ALAS I Fuel Sender Kit

**Fuel Level Gauge and Sender Kits, Electrical, 2 1/16" (52mm) Dia**

Catalog Number	Description
A2C53412991-K	Fuel Gauge 12/24V and ALAS I Fuel Sender Kit



A2C53191761-S

**Fuel Level Gauges, Electrical, 2 1/16" (52mm) Dia**

Catalog Number	Description	See Sender Table
A2C53191761-S	Fuel Gauge 12V, Use with 3-180 Ohm Sender	ALAS I & II
A2C53412991-S	0-1/1 Fuel Gauge 12/24V, Use with 3-180 Ohm Sender	ALAS I & II
A2C53191762-S	Fuel Gauge 12V 0-1/1, Use with 90-0 Ohm Sender	Tube Type Fuel
A2C53191763-S	Fuel Gauge 12V, Use with 240-33 Ohm Sender	ALAS I & II
A2C53412993-S	Fuel Gauge 12/24V, Use with 240-33 Ohm Sender	ALAS I & II
A2C53191765-S	Fuel Gauge 12V, Use with VDO Tube Type Sender	Tube Type Fuel
A2C53412995-S	Fuel Gauge 12/24V, Use with VDO Tube Type Sender	Tube Type Fuel



A2C53210956-K

**Ammeter and Shunt Kits, 2 1/8" (52mm) dia**

Catalog Number	Description
A2C53210956-K	150A Ammeter, Includes Required Shunt
A2C53210958-K	60A Ammeter, Includes Required Shunt
A2C53210974-K	100A Ammeter, Includes Required Shunt
A2C53211037-K	30A Ammeter, Includes Required Shunt



A2C53210974-S

**Ammeters (external shunt required), 2 1/16" (52mm) Dia**

Catalog Number	Description
A2C53210956-S	150A Ammeter 12/24V, Requires External 60mv Shunt
A2C53210958-S	60A Ammeter 12/24V, Requires External 60mv Shunt
A2C53210974-S	100A Ammeter 12/24V, Requires External 60mv Shunt
A2C53211037-S	30A Ammeter 12/24V, Requires External 60mv Shunt



A2C53191768-S

**Voltmeters, 2 1/16" (52mm) Dia**

Catalog Number	Description
A2C53191768-S	12V Voltmeter
A2C53191769-S	24V Voltmeter

**Hourmeters, 2 1/16" (52mm) Dia**

Catalog Number	Description
A2C59510877-S	Hourmeter 12/24V

**Clocks, Electrical, 2 1/16" (52mm) Dia**

Catalog Number	Description
A2C53311885-S	Analog Clock 12V
A2C53321688-S	Analog Clock 24V



Viewline Ivory with black triangle bezel

Viewline Ivory with white round bezel



Viewline Sterling with chrome triangle bezel

### Complete Instrument Kits

A2C59519565	4 Gauge Kit with Multifunction Tachometer for Outboards
A2C59519571	Premium 7 Gauge Kit for Inboards. Complete with VDO Senders

### 4 Gauge Kit for Outboards

- 50 MPH Pitot Speedometer
- 8,000 RPM Tachometer with Multifunction LCD
- 8-16V Voltmeter
- 30 PSI Water Pressure Gauge

### 7 Gauge Kits for Inboards

- 50 MPH Pitot Speedometer
- 6,000 RPM Tachometer
- 80 PSI Oil Pressure Gauge, Electrical.
- 240°F Temperature Gauge, Electrical
- Fuel Gauge
- 8-16V Voltmeter
- Trim Gauge

Fuel, oil pressure and water temperature gauges are designed to work with common marine senders (not included)

### 7 Gauge Premium Kits:

- Same contents as 7 Gauge Kits for Inboards except:
- Substitute with 8,000 RPM Tachometer with Multi-function LCD
- Substitute with 250°F temperature gauge, electrical
- Supplied with:
  - 80 PSI oil pressure sender with low pressure warning contact
  - 250°F temperature sender
  - 221°F temperature switch
  - ALAS I fuel sender with low fuel warning contact
  - 1/2" Adapter fro Temperature Sender
  - 1/8x27 NPTF x 1/4", 3/8" and 1/2" adapter kit for pressure sender

### All Instrument Kits Feature Chrome Bezels



A2C59513644-S

### Pitot Speedometers

Catalog Number	Description
A2C59513644-S	50 MPH 3 3/8" (85mm) Pitot Speedometer 12V
A2C59513647-S	80 MPH 3 3/8" (85mm) Pitot Speedometer 12V



A2C53408402-S

### Programmable Tachometers with Multifunction LCD

Programmable tachometers feature: User defined rev. limit warning, LCD display for total hours, resettable hours, voltage and clock. Accepts signal inputs from electronic controlled ignitions with tachometer output terminal, standard coil ignition, alternator signal and 12V square wave applications.

Catalog Number	Description
A2C53408402-S	8,000 RPM 3 3/8" (85mm) Tachometer with 2 Hourmeters, Clock and Voltmeter 12/24V



A2C32562000-S

### Marine Programmable Tachometers with Multifunction LCD

Specially designed for marine applications. Includes warning tell-tales for bilge pump operation, bilge blower operation, bow light on, anchor light on and check engine. Programmable tachometers features: User defined rev. limit warning, LCD display for total hours, resettable hours, voltage and clock. Accepts signal inputs from electronic controlled ignitions with tachometer output terminal, standard coil ignition, alternator signal and 12V square wave applications.

Catalog Number	Description
A2C32562000-S	6,000 RPM 3 3/8" (85mm) Marine Tachometer with 2 Hourmeters, Clock and Voltmeter 12/24V



A2C53408445-S

### Programmable Tachometers

Programmable tachometers accept signal inputs from 2,4,6,8,10,12 & 16 cylinder standard coil ignition, alternator signal and 12V square wave applications. User defined rev. limit warning and programming can be done using Viewline programming software (available separately).

Catalog Number	Description
A2C53408445-S	8,000 RPM 3 3/8" (85mm) Tachometer 12/24V



A2C53406050-K

### Fluid Temperature Gauge and Sender Kits, Electrical, 2 1/16" (52mm) Dia

Catalog Number	Description
A2C53406050-K1	250°F Water Temperature Gauge 12V with Sender Kit US Thread Adapters
A2C53406050-K2	250°F Water Temperature Gauge 12V with Sender Kit Metric Thread Adapters
A2C53406051-K1	250°F/120°C Water Temperature Gauge 12V with Sender Kit US Thread Adapters
A2C53406051-K2	250°F/120°C Water Temperature Gauge 12V with Sender Kit Metric Thread Adapters

### Fluid Temperature Gauges, Electrical, 2 1/16" (52mm) Dia

Catalog Number	Description	See Sender Table
A2C53406050-S	250°F Water Temperature Gauge 12V, Use with VDO Sender	A
A2C53406051-S	250°F/120°C Water Temperature Gauge 12V, Use with VDO Sender	A
A2C53407554-S	240°F Water Temperature Gauge 12V, Use with US Sender	D



A2C53406052-K1

### Oil Pressure Gauge and Sender Kits, Electrical, 2 1/16" (52mm) Dia

Catalog Number	Description
A2C53406052-K1	80 PSI Oil Pressure Gauge 12V and VDO Sender with US Thread Adapters
A2C53406052-K2	80 PSI Oil Pressure Gauge 12V and Sender Kit Metric Thread Adapters
A2C53406053-K1	80 PSI/5 bar Oil Pressure Gauge 12V and Sender Kit US Thread Adapters
A2C53406053-K2	80 PSI/5 bar Oil Pressure Gauge 12V and Sender Kit Metric Thread Adapters

### Oil Pressure Gauges, Electrical, 2 1/16" (52mm) Dia

Catalog Number	Description	See Sender Table
A2C53406052-S	80 PSI Oil Pressure Gauge 12V, Use with VDO Sender	1
A2C53406053-S	80 PSI/5 bar Oil Pressure Gauge 12V, Use with VDO Sender	1

### Water Pressure Gauges, Mechanical, 2 1/16" (52mm) Dia

Catalog Number	Description
A2C59513650-S	30 PSI Water Pressure Gauge 12V
A2C59513653-S	40 PSI Water Pressure Gauge 12V



A2C53406055-S

### Power Trim, 2 1/16" (52mm) Dia

Catalog Number	Description
A2C53406055-S	Trim Gauge 12V, Use with Mercury/Volvo Penta/2001+ Yamaha



A2C53406054-S

### Fuel Level Gauge and Sender Kits, 2 1/16" (52mm) Dia

Catalog Number	Description
A2C53406054-K	Fuel Gauge 12V and ALAS I Fuel Sender Kit

### Fuel Level Gauges, Electrical, 2 1/16" (52mm) Dia

Catalog Number	Description	See Sender Table
A2C53406054-S	Fuel Gauge 12V, Use with 3-180 Ohm Sender	ALAS I & II



A2C53406019-S

### Voltmeters, 2 1/16" (52mm) Dia

Catalog Number	Description
A2C53406019-S	12V Voltmeter



# Viewline Bezels and Harnesses

## Viewline Bezels

### 52MM Viewline Bezels

	Size	Color	Shape
A2C53186027-S	2 1/16 in (52mm)	Black	Round
A2C53186029-S	2 1/16 in (52mm)	Chrome	Round
A2C53186028-S	2 1/16 in (52mm)	White	Round
A2C53186024-S	2 1/16 in (52mm)	Black	Triangle
A2C53186026-S	2 1/16 in (52mm)	Chrome	Triangle
A2C53186025-S	2 1/16 in (52mm)	White	Triangle

### 85MM Viewline Bezels

	Size	Color	Shape
A2C53192913-S	3 9/16 in (85mm)	Black	Round
A2C53192914-S	3 9/16 in (85mm)	Chrome	Round
A2C53192916-S	3 9/16 in (85mm)	White	Round
A2C53192917-S	3 9/16 in (85mm)	Black	Triangle
A2C53192918-S	3 9/16 in (85mm)	Chrome	Triangle
A2C53192920-S	3 9/16 in (85mm)	White	Triangle

### 110MM (5" Dial) Viewline Bezels

	Size	Color	Shape
A2C53210749-S	4 1/4 in (110mm)	Black	Round
A2C53210761-S	4 1/4 in (110mm)	Chrome	Round
A2C53210760-S	4 1/4 in (110mm)	White	Round
A2C53210763-S	4 1/4 in (110mm)	Black	Triangle
A2C53210765-S	4 1/4 in (110mm)	Chrome	Triangle
A2C53210764-S	4 1/4 in (110mm)	White	Triangle

All bezels are available in 10 pack bulk by changing part number suffix to a "B"



## Viewline Installation Parts

### Programming & Mode Button for Viewline

240-046	Programming & Mode Button for Viewline Speedometer or Tachometer - .250" Spade Connector. Black with Chrome Surround
240 205	Programming & Mode Button for Viewline Speedometer or Tachometer - 1/8" Spade Connector. Black with Black Surround

### Wiring Harness & Accessories for Viewline

240-098M	14 pole Connector and Pins for 1 Viewline Instrument
240 099	14 pole Connector for Viewline
240 098	8 pole Connector for Viewline
A2C53422790-S	8 pole Connector and Pins for 1 Viewline Instrument
240 204	8 pole Retrofit Harness for Viewline
240 201	Programming & Mode Button for Viewline Speedometer or Tachometer - .250" Spade Connector
240 202	Connection Pins for Viewline Connector
240 097	8 pole Harness with 500mm Leads for Viewline Voltmeter, Hourmeter or Clock
A2C59513503-S	Adapter Harness from Viewline Sumlog to Sender
240 048	8 pole Harness with Leads for Viewline Ammeter
240 048M	14 pole Harness with 500mm Leads for 1 Viewline Speedometer or Tachometer







Vision Chrome features crisp black dials and polished chrome bezels. High contrast clear white graphics and red pointers make Vision instruments easy to read. VDO patented movements provide smooth and accurate performance and long life dependability.

Standard 0.25" spade connectors simplify wiring and VDO Spin-lok™ mounting makes installation fast and easy while providing a full 360° degrees of mounting force. Included light diffusers allow the dial illumination color to be changed to red or green.

### Complete Instrument Kits

600 9327	6 Gauge Kit for Inboards. Use with Common Marine Senders (not included)
----------	---

### Instrument Kit Contents

- 50 MPH Pitot Speedometer
- 6,000 RPM Tachometer
- 80 PSI Oil Pressure Gauge, Electrical.
- 220°F Temperature Gauge, Electrical
- Fuel Gauge

- 8-16V Voltmeter
- Installation instructions

Fuel, oil pressure and water temperature gauges are designed to work with common marine senders (not included)

**See page 57 for complete wire harness assembly**

### Pitot Speedometers

Catalog Number	Description
260 193	35 MPH 3 9/16" (85mm) Pitot Speedometer, 12V
260 191	50 MPH 3 9/16" (85mm) Pitot Speedometer, 12V
260 194	80 MPH 3 9/16" (85mm) Pitot Speedometer, 12V

Use with existing pitot sender or VDO 270 900 pitot kit

### Programmable Tachometers

For use on 4,5,6 & 8 cylinder application engines with standard coil ignitions, most square wave electronic control ignitions with tachometer output terminal and alternators with "w" tachometer terminal.

Catalog Number	Description
333 195	8,000 RPM 4" Tachometer, 12V
333 199	3,000 RPM 3 9/16" Tachometer, 12V
333 197	6,000 RPM 3 9/16" Tachometer, 12V

### Programmable Tachometers with LCD Hourmeter

Programmable for use with most electronic controlled ignitions with tachometer output terminal, standard coil ignition, alternator signal and 12V square wave applications. Non resettable engine hour meter is displayed in LCD window.

Catalog Number	Description
333 192	3,000 RPM 3 9/16" Tachometer with Hourmeter, 12/24V
333 193	4,000 RPM 3 9/16" Tachometer with Hourmeter, 12/24V
333 194	6,000 RPM 3 9/16" Tachometer with Hourmeter, 12/24V

### Engine Synchronizers

For use on 4,5,6 & 8 cylinder application engines with standard coil ignitions, most square wave electronic control ignitions with tachometer output terminal and alternators with "w" tachometer terminal.

Catalog Number	Description
333 196	3 9/16" Synchronizer, 12/24V

### Fluid Temperature Gauges, Electrical, 2 1/16" (52mm) Dia

Catalog Number	Description	See Sender Table
310 196	300°F Temperature Gauge, Use with VDO Sender, 12V	B
310 1961	300°F Temperature Gauge with VDO Sender and US Thread Adapters, 12V	
310 1962	300°F Temperature Gauge with VDO Sender and Metric Thread Adapters, 12V	
310 194	220°F Temperature Gauge, Use with US Ohm Sender, 12V	D
310 195	250°F Temperature Gauge, Use with VDO Sender, 12V	A
310 1951	250°F Temperature Gauge with VDO Sender and US Thread Adapters, 12V	
310 1952	250°F Temperature Gauge with VDO Sender and Metric Thread Adapters, 12V	

### Pyrometer, Electrical, 2 1/16" (52mm) Dia

Catalog Number	Description
310 191	1600°F Pyrometer, 12V
310 193	1600°F Pyrometer with Sender and Harness, 12V

### Oil Pressure Gauges, Electrical, 2 1/16" (52mm) Dia

Catalog Number	Description	See Sender Table
350 194	80 PSI Oil Pressure Gauge, Use with VDO Sender, 12V	1
350 1941	80 PSI Oil Pressure Gauge with VDO Sender and US Thread Adapters, 12V	
350 1942	80 PSI Oil Pressure Gauge with VDO Sender and Metric Thread Adapters, 12V	
350 195	80 PSI Oil Pressure Gauge, Use with US Sender, 12V	2
350 196	100 PSI Oil Pressure Gauge, Use with VDO Sender, 12V	3
350 1961	100 PSI Oil Pressure Gauge with VDO Sender and US Thread Adapters, 12V	
350 1962	100 PSI Oil Pressure Gauge with VDO Sender and Metric Thread Adapters, 12V	
350 198	150 PSI Oil Pressure Gauge, Use with VDO Sender, 12V	5
350 1981	150 PSI Oil Pressure Gauge with VDO Sender and US Thread Adapters, 12V	
350 1982	150 PSI Oil Pressure Gauge with VDO Sender and Metric Thread Adapters, 12V	
350 199	150 PSI Oil Pressure Gauge, Use with US Sender, 12V	
350 290	400 PSI Oil Pressure Gauge, Use with VDO Sender, 12V	7

See page 48 for tachometer senders, See page 43-44 for pressure senders, See page 45-46 for temperature senders



### Fuel Level Gauges, Electrical, 2 1/16" (52mm) Dia

Catalog Number	Description	See Sender Table
301 194	Fuel Gauge, Use with 10-184 Ohm Sender, 12V	ALAS
301 194K	Fuel Gauge and ALAS Fuel Sender Kit, 12V	
301 195	Fuel Gauge, Use with 240-33 Ohm Sender, 12V	ALAS
301 197	Fuel Gauge, Use with VDO Tube Type Sender, 12V	Tube Type Fuel

### Voltmeters, 2 1/16" (52mm) Dia

Catalog Number	Description
332 191	24V Voltmeter
332 193	12V Voltmeter

### Hourmeters, 2 1/16" (52mm) Dia

Catalog Number	Description
331 955	Hourmeter, 100K Hours, Non Illuminated, 12V

### Power Trim, 2 1/16" (52mm) Dia

Catalog Number	Description
382 192	Trim Gauge for Mercury/Volvo Penta/2001+ Yamaha, 12V



Crisp black dials and matching bezels, along with VDO's Tri-optic through dial illumination make Vision a solid choice for small fishing and pleasure boats. High contrast clear white graphics and red pointers make Vision instruments easy to read, while VDO patented movements provide smooth and

accurate performance and long life dependability. Standard 0.25" spade connectors simplify wiring and VDO Spin-lok™ mounting makes installation fast and easy while providing a full 360° degrees of mounting force. Included light diffusers allow the dial illumination color to be changed to red or green.

### Complete Instrument Kits

600 9232	6 Gauge Kit for Inboards, Use with Common Marine Senders (not included)
----------	---

### 6 Gauge Kits for Inboards

- 50 MPH Pitot Speedometer
- 7,000 RPM Tachometer
- 80 PSI Oil Pressure Gauge, Electrical
- 220°F Temperature Gauge, Electrical
- Fuel Gauge

- 8-16V Voltmeter
- Installation instructions

Fuel, oil pressure and water temperature gauges are designed to work with common marine senders (not included)

**See page 57 for complete wire harness assembly**

### Pitot Speedometers

Catalog Number	Description
260 111	50 MPH 3 9/16" (85mm) Pitot Speedometer, 12V
260 101	80 MPH 3 9/16" (85mm) Pitot Speedometer, 12V
260 103	35 MPH 3 9/16" (85mm) Pitot Speedometer, 12V



## Electronic Speedometers. Use with VDO 340 786 GPS Speed Sender

Speedometers features push button odometer and trip odometer clearly displayed in the LCD window. Unique auto-calibration feature allows for easy adjustment and can be used with Hall Effect and inductive senders or most electronic controlled transmission outputs

Catalog Number	Description
437 152	85MPH/130kmh 3 3/8" Electronic Speedometer with Autocalibration, 12V

## Programmable Tachometers

For use on 4,5,6 & 8 cylinder application engines with standard coil ignitions, most square wave electronic control ignitions with tachometer output terminal and alternators with "w" tachometer terminal.

Catalog Number	Description
333 158	6,000 RPM 2 1/16" Tachometer, 12V
333 159	8,000 RPM 2 1/16" Tachometer, 12V
333 160	8,000 RPM 4" Tachometer, 12V
333-990	8,000 RPM 2 1/16" Tachometer and Black Mounting Cup, 12V
333-992	8,000 RPM 2 1/16" Tachometer and Chrome Mounting Cup, 12V
333 156	4,000 RPM 2 1/16" Tachometer, 12V
333 155	7,000 RPM 3 3/8" Tachometer, 12V
333 152	3,000 RPM 3 3/8" Tachometer, 12V
333 151	7,000 RPM 3 1/8" Tachometer, 12V

## Programmable Tachometers with LCD Hourmeter

Programmable for use with most electronic controlled ignitions with tachometer output terminal, standard coil ignition, alternator signal and 12V square wave applications. NonOresettable engine hour meter is displayed in LCD window.

Catalog Number	Description
333 164	6,000 RPM 3 3/8" Tachometer with Hourmeter, 12/24V
333 163	4,000 RPM 3 3/8" Tachometer with Hourmeter, 12/24V
333 162	3,000 RPM 3 3/8" Tachometer with Hourmeter, 12/24V

## Fluid Temperature Gauges, Electrical, 2 1/16" (52mm) Dia

Catalog Number	Description	See Sender Table
310 106	300°F Oil Temperature Gauge, Use with VDO Sender, 12V	B
310 1061	300°F Oil Temperature Gauge with VDO Sender and US Thread Adapters, 12V	
310 1062	300°F Oil Temperature Gauge with VDO Sender and Metric Thread Adapters, 12V	
310 107	400°F Transmission Temperature Gauge, Use with VDO Sender, 12V	C
310 1071	400°F Transmission Temperature Gauge with VDO Sender and US Thread Adapters, 12V	
310 1072	400°F Transmission Temperature Gauge with VDO Sender and Metric Thread Adapters, 12V	
310 111	300°F Transmission Temperature Gauge, Use with VDO Sender, 12V	B
310 104	220°F Water Temperature Gauge, Use with US Sender, 12V	D
310 105	250°F Water Temperature Gauge, Use with VDO Sender, 12V	A
310 1051	250°F Water Temperature Gauge with VDO Sender and US Thread Adapters, 12V	
310 1052	250°F Water Temperature Gauge with VDO Sender and Metric Thread Adapters, 12V	

## Outside Temperature Gauges, Electrical, 2 1/16" (52mm) Dia

Catalog Number	Description
397 154	120°F Outside Temperature Gauge Kit with Sender and Harness, 12V

## Pyrometer, Electrical, 2 1/16" (52mm) Dia

Catalog Number	Description
310 151	1600°F Pyrometer, Requires 323 892 Sender, 12V
310 153	1600°F Pyrometer with Sender and Harness, 12V

## Oil Pressure Gauges, Electrical, 2 1/16" (52mm) Dia

Catalog Number	Description	See Sender Table
350 108	150 PSI Oil Pressure Gauge, Use with VDO Sender, 12V	5
350 1081	150 PSI Oil Pressure Gauge with VDO Sender and US Thread Adapters, 12V	
350 1082	150 PSI Oil Pressure Gauge with VDO Sender and Metric Thread Adapters, 12V	
350 109	150 PSI Oil Pressure Gauge, Use with US Sender, 12V	
350 106	100 PSI Oil Pressure Gauge, Use with VDO Sender, 12V	3
350 1061	100 PSI Oil Pressure Gauge with VDO Sender and US Thread Adapters, 12V	
350 1062	100 PSI Oil Pressure Gauge with VDO Sender and Metric Thread Adapters, 12V	
350 107	100 PSI Oil Pressure Gauge, Use with US Sender, 12V	4
350 104	80 PSI Oil Pressure Gauge, Use with VDO Sender, 12V	1
350 1041	80 PSI Oil Pressure Gauge with VDO Sender and US Thread Adapters, 12V	
350 1042	80 PSI Oil Pressure Gauge with VDO Sender and Metric Thread Adapters, 12V	
350 105	80 PSI Oil Pressure Gauge, Use with US Sender, 12V	2
350 110	400 PSI Oil Pressure Gauge, Use with VDO Sender, 12V	7

## Turbo & Boost Gauges, Mechanical, 2 1/16" (52mm) Dia

Catalog Number	Description
150 1011	15 PSI Mechanical Boost Gauge with Tubing and US Thread Adapters, 12V

## Fuel Level Gauges, Electrical, 2 1/16" (52mm) Dia

Catalog Number	Description	See Sender Table
301 104	Fuel Gauge, Use with 10-184 Ohm Sender, 12V	ALAS
301 104K	Fuel Gauge and ALAS Fuel Sender Kit, 12V	
301 105	Fuel Gauge, Use with 240-33 Ohm Sender, 12V	ALAS
301 107	Fuel Gauge, Use with VDO Tube Type Sender, 12V	Tube Type Fuel

## Voltmeters, 2 1/16" (52mm) Dia

Catalog Number	Description
332 103	12V Voltmeter
332 104	24V Voltmeter

## Ammeters (external shunt required), 2 1/16" (52mm) Dia

Catalog Number	Description
190 151	150A Ammeter, Requires External Shunt 391 007, 12V

## Ammeters (no external shunt required), 2 1/16" (52mm) Dia

Catalog Number	Description
190 104	60A Ammeter, Does Not Require External Shunt, 12V
190 105	100A Ammeter, Does Not Require External Shunt, 12V

## Clocks, Electrical, 2 1/16" (52mm) Dia

Catalog Number	Description
370 100	Quartz Analog Clock, 12/24V
370 155	Analog Clock, 12/24V

## Power Trim, 2 1/16" (52mm) Dia

Catalog Number	Description
382 152	Trim Gauge for Mercury/Volvo Penta/2001+ Yamaha, 12V





World-class Cockpit International instruments are the standard in the industry for reliability and economy. These instruments feature our latest generation patented air core movements or stepper motor technology to deliver the precision and durability that has made VDO renowned as the leading brand in instrumentation. VDO Cockpit International instruments are

made for durability with a choice of two terminals: M4 studs or .250" male spades. Most 2 1/16" (52mm) instruments feature zinc-plated metal housing and black painted, brass bezels for rugged, reliable service. Cockpit International Instruments feature standard flood-lit illumination and are available in 12 / 24V applications.

### Electronic Speedometers. Use with VDO 340 786 GPS Speed Sender

Speedometer features push button display for trip distance and total distance traveled. Unique auto-calibration feature allows for easy adjustment and can be used with paddle wheel and inductive senders

Catalog Number	Description
437 950	45MPH/70kmh 3 3/8" (85mm) Electronic Speedometer, 12/24V.

### Programmable Tachometers

For use on 4,5,6 & 8 cylinder application engines with standard coil ignitions, most square wave electronic control ignitions with tachometer output terminal and alternators with "w" tachometer terminal.

Catalog Number	Description
333 958	6,000 RPM 2 1/16" (52mm) Tachometer, 12V
333 959	8,000 RPM 2 1/16" (52mm) Tachometer, 12V
333 965	4,000 RPM 2 1/16" (52mm) Tachometer, 12V
333 966	3,000 RPM 4" (100mm) Tachometer, 12V
333 953	4,000 RPM 3 3/8" (85mm) Tachometer, 12V
333 952	3,000 RPM 3 3/8" (85mm) Tachometer, 12V

### Programmable Tachometers with LCD Hourmeter

Programmable for use with most electronic controlled ignitions with tachometer output terminal, standard coil ignition, alternator signal and 12V square wave applications. Non resettable engine hour meter is displayed in LCD window.

Catalog Number	Description
333 963	4,000 RPM 3 3/8" (85mm) Tachometer with Hourmeter, 12/24V
333 962	3,000 RPM 3 3/8" (85mm) Tachometer with Hourmeter, 12/24V

### Fluid Temperature Gauges, Electrical, 2 1/16" (52mm) Dia

Catalog Number	Description	See Sender Table
310 915	300°F /150°C Gear Temperature Gauge, Use with VDO Sender, 12V, .250" Spade Connection	B
310 916	300°F /150°C Gear Temperature Gauge, Use with VDO Sender, 24V, M4 Stud Connection	B
310 936	300°F /150°C Gear Temperature Gauge, Use with VDO Sender, 12V, .250" Spade Connection	B
310 909	250°F/120°C Water Temperature Gauge, Use with VDO Sender, 12V, M4 Stud Connection	A
310 910	250°F/120°C Water Temperature Gauge, Use with VDO Sender, 12V, 24V, M4 Stud Connection	A
310 934	250°F/120°C Water Temperature Gauge, Use with VDO Sender, 12V, .250" Spade Connection	A

### Fluid Temperature Gauges, Mechanical, 2 1/16" (52mm) Dia

Catalog Number	Description
180 901	265°F/130°C Mechanical Temperature Gauge with 72" Capillary, 12V
180 902	265°F/130°C Mechanical Temperature Gauge with 96" Capillary, 12V
180 903	265°F/130°C Mechanical Temperature Gauge with 144" Capillary, 12V

### Pyrometer, Electrical, 2 1/16" (52mm) Dia

Catalog Number	Description
310 953	1650°F Pyrometer, 12V with Sender and Harness

### Oil Pressure Gauges, Electrical, 2 1/16" (52mm) Dia

Catalog Number	Description	See Sender Table
350 901	80 PSI/5 bar Oil Pressure Gauge, for VDO Sender, 12V, M4 Stud Connection	1
350 934	80 PSI/5 bar Oil Pressure Gauge, for VDO Sender, 12V, .250" Spade Connection	1
350 902	80 PSI/5 bar Oil Pressure Gauge, for VDO Sender, 24V, M4 Stud Connection	1
350 905	100 PSI/7 bar Oil Pressure Gauge, Use with VDO Sender, 12V, M4 Stud Connection	3
350 909	150 PSI/10 bar Oil Pressure Gauge, Use with VDO Sender, 12V, M4 Stud Connection	5
350 910	150 PSI/10 bar Oil Pressure Gauge, Use with VDO Sender, 24V, M4 Stud Connection	5
350 911	150 PSI/10 bar Oil Pressure Gauge, Use with VDO Sender, 12V, .250" Spade Connection	5
350 913	400 PSI/25 bar Gear Pressure Gauge, Use with VDO Sender, 12V, M4 Stud Connection	7

### Oil Pressure Gauges, Mechanical, 2 1/16" (52mm) Dia

Catalog Number	Description
150 904	150 PSI/10 bar Mechanical Oil Pressure Gauge, 12V
150 906	400 PSI/25 bar Mechanical Oil Pressure Gauge, 12V

### Air Pressure Gauges, Mechanical, 2 1/16" (52mm) Dia

Catalog Number	Description
150 905	150 PSI/10 bar Mechanical Air Pressure Gauge, 12V

### Turbo & Boost Gauges, Mechanical, 2 1/16" (52mm) Dia

Catalog Number	Description
150 921	30" HG/1 bar-20 PSI/2 bar Mechanical Turbo Gauge, 12V

### Fuel Level Gauges, Electrical, 2 1/16" (52mm) Dia

Catalog Number	Description	See Sender Table
301 910	Fuel Gauge, Use with Tube Type Sender, 12V, .250" Spade Connection	Tube Type Fuel
301 911	Fuel Gauge, Use with Tube Type Sender, 24V, .250" Spade Connection	Tube Type Fuel
301 901	Fuel Gauge, Use with 10-184 Ohm Sender, 12V, M4 Stud Connection	ALAS
301 903	Fuel Gauge, Use with 240-33 Ohm Sender, 12V, M4 Stud Connection	ALAS
301 905	Fuel Gauge, Use with Tube Type Sender, 12V, M4 Stud Connection	Tube Type Fuel
301 906	Fuel Gauge, Use with Tube Type Sender, 24V, .250" Spade Connection	Tube Type Fuel
301 907	Fuel Gauge, Use with 10-184 Ohm Sender, 12V, .250" Spade Connection	ALAS
301 902	Fuel Gauge, Use with 10-184 Ohm Sender, 24V, M4 Stud Connection	ALAS
301 904	Fuel Gauge, Use with 240-33 Ohm Sender, 24V, M4 Stud Connection	ALAS

## Voltmeters, 2 1/16" (52mm) Dia

Catalog Number	Description
332 932	12V Voltmeter, .250" Spade Connection
332 901	12V Voltmeter, M4 Stud Connection
332 902	24V Voltmeter, M4 Stud Connection
332 933	24V Voltmeter, .250" Spade Connection

## Ammeters (external shunt required), 2 1/16" (52mm) Dia

Catalog Number	Description
190 963	300A Ammeter, Requires External Shunt 391 009, 12V
190 966	300A Ammeter Kit with External Shunt, 12V

## Ammeters (no external shunt required), 2 1/16" (52mm) Dia

Catalog Number	Description
190 903	30A Ammeter, Does Not Require External Shunt, 12V
190 904	60A Ammeter, Does Not Require External Shunt, 12V

## Hourmeters, 2 1/16" (52mm) Dia

Catalog Number	Description
331 953	Hourmeter, 100K Hours, Non Illuminated, 12V
331 957	Hourmeter, 100K Hours, Illuminated, 12V
331 960	Hourmeter, 100K Hours, Illuminated, 24V

## Hourmeters, 2 1/16" (52mm) Dia w/ minute hand

Catalog Number	Description
331 959	Hourmeter, 100K Hours, Non Illuminated, 12V, with minute hand

## Clocks, Electrical, 2 1/16" (52mm) Dia

Catalog Number	Description
370 955	Analog Clock, 12V



J1939 CAN Bus solution designed specifically for marine environments! IP67 water protection, dual lenses and corrosion proof housing ensure extreme service life, while Ocean Link's plug-n-play software make installation simple

and fast. Ocean Link's master tachometer with multifunction LCD's can support up to 20 separate satellite gauges, all of which feature built in pigtailed for simplified daisy-chaining.

### Master Tachometer

Catalog Number	Description
A2C59500012	5,000 RPM 3 9/16" (85mm), 12/24V Master Tachometer
N02-012-920	3,000 RPM 3 9/16" (85mm), 12/24V Master Tachometer
N02-012-922	4,000 RPM 3 9/16" (85mm), 12/24V Master Tachometer

### Satellite Temperature Gauges

Catalog Number	Description
N02-311-544	300°F Gear Temperature Gauge, 12/24V
N02-311-542	300°F Water Temperature Gauge, 12/24V
N02-311-552	250°F Water Temperature Gauge, 12/24V
N02-311-546	1700F Exhaust Temperature Gauge, 12/24V

### Satellite Pressure Gauges

Catalog Number	Description
N02-140-512	150 PSI Oil Pressure Gauge, 12/24V
N02-140-516	300 PSI Gear Pressure Gauge, 12/24V

### Satellite Fuel Level Gauges

Catalog Number	Description
N02-224-080	Fuel Level Gauge, 12/24V

### Satellite Voltmeters

Catalog Number	Description
N02-413-058	24V Voltmeter
N02-413-066	12V Voltmeter

### Ocean Link Wire Harness

Catalog Number	Description
A2C53092432	Input Harness to Master. Supports CAN & Two Analog Inputs





# Hourmeters

The VDO hourmeter line has been expanded to offer hourmeters in many sizes, styles and configurations. They include models which are illuminated and non-illuminated

and have recording hour ranges from 10,000 to 100,000 hours. VDO hourmeters are not resettable.

## Mini w/ 2 hole mounting flange, Electrical, 1.42"Wx.92"Hx2.91"D (36mmx23.4mmx71.1mm)



Catalog Number	Description
331 536	2 Hole Flange Hourmeter, 10K Hours, Non Illuminated, 12-60V

## Mini w/ flush mount flange, Electrical, 1.42"Wx.92"Hx2.91"D (36mmx23.4mmx71.1mm)



Catalog Number	Description
331 537	Flush Mount Hourmeter, 100K Hours, Non Illuminated, 12-60V

## Viewline Onyx

### Hourmeters, 2 1/16" (52mm) Dia



Catalog Number	Description
A2C59510876-S	Hourmeter 12/24V

## Viewline Ivory

### Hourmeters, 2 1/16" (52mm) Dia



Catalog Number	Description
A2C59510877-S	Hourmeter 12/24V

# Hourmeters

## Vision Chrome

### Hourmeters, 2 1/16" (52mm) Dia



Catalog Number	Description
331 955	Hourmeter, 100K Hours, Non Illuminated, 12V

## Cockpit International

### Hourmeters, 2 1/16" (52mm) Dia



Catalog Number	Description
331 957	Hourmeter, 100K Hours, Illuminated, 12V
331 960	Hourmeter, 100K Hours, Illuminated, 24V
331 953	Hourmeter, 100K Hours, Non Illuminated, 12V

### Hourmeters, 2 1/16" (52mm) Dia w/ minute hand



Catalog Number	Description
331 959	Hourmeter, 100K Hours, Non Illuminated, 12V, with minute hand



# Pressure Senders & Switches

Note: All Pressure senders are designed to work with VDO gauges only, unless otherwise noted. Senders are matched to gauges according to maximum reading on dial face. All senders are standard ground (sender case to common ground)

Please note: VDO senders have tapered threads and DO NOT require the use of Teflon tape or pipe sealant. This will interfere with grounding causing incorrect instrument readings.



## VDO Pressure & Temperature Senders

Using the expertise we've gained in developing specialized solutions for many of the world's leading marine manufacturers, we offer a large portfolio of pressure and temperature senders for the aftermarket. Unlike many companies today, we manufacture our senders in our own ISO and TSO registered facilities, using the same quality materials and engineering processes, to meet the same quality standards as our OE products.

With optional features such as floating ground, warning contact point to control warning lights and/or warning alarms and dual station (twin gauge) capability, VDO senders offer more choices to meet your specific needs

With VDO senders, you can count on the performance that you would expect from one of the largest marine suppliers in the world. Designed to meet the challenges of some of the most demanding OE applications, VDO pressure and temperature senders are engineered to deliver maximum performance for years of trouble free service.



Pressure Sender Kits

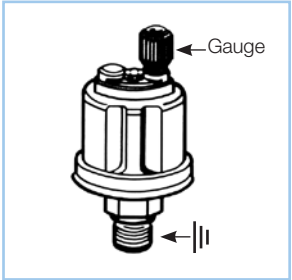

Standard Ground: sender case to common ground; and Dual Station Standard Ground

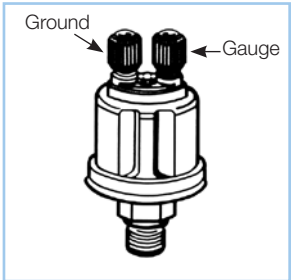

Floating Ground: isolated terminal to common ground; and Dual Station Floating Ground

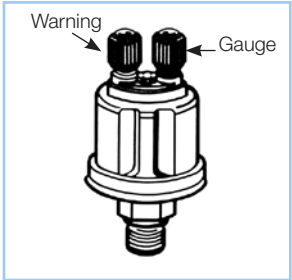

Standard Ground with Warning Contact

### Pressure Sender & Adapter Kits

VDO universal sender kits include 1/8-27NPT common ground pressure sender, spade connector and US thread adapter kit for 1/4-18, 3/8-18 and 1/2-14 NPT threads.

Catalog Number	Description
360 905	150PSI/5bar with US Thread Adapters
360 900	80PSI/5bar with US Thread Adapters

### Table 1: 80PSI / 5 bar (10-180Ohm) Pressure Senders

Thread	Warning Contact Point	Ground	Component Reference #	Connection	Catalog #
1/4-18NPTF	8 PSI	Standard	30/20	Knurled Nut	360 019
1/4-18NPTF		Standard	29/8	Knurled Nut	360 005
1/8-27NPTF		Standard	29/4	Knurled Nut	360 003
1/8-27NPTF		Standard	3/1	.250" Spade	<b>362 033</b>
1/8-27NPTF		Floating	1/1	.250" Spade	<b>362 001</b>
1/8-27NPTF		Floating	32/1	Knurled Nut	360 410
M10x1.0		Standard	29/1	Knurled Nut	360 001
M12x1.5		Standard	29/85	Knurled Nut	360 002
M10x1.0	12 PSI	Standard	30/4	Knurled Nut	360 034
1/8-27NPTF		Standard	30/23	Knurled Nut	360 009
M10x1.0	7 PSI	Standard	30/2	Knurled Nut	360 006
M14x1.5	7 PSI	Standard	30/28	Knurled Nut	360 028
M12x1.5	8.5 PSI	Standard	30/6	Knurled Nut	360 007

### Table 2: 80PSI / 5 bar (240-330Ohm) Pressure Senders

Thread	Warning Contact Point	Ground	Component Reference #	Connection	Catalog #
1/8-27NPTF		Standard	AT84200	10-32 Stud	360 801

### Table 3: 100PSI / 7 bar (10-180Ohm) Pressure Senders

Thread	Warning Contact Point	Ground	Component Reference #	Connection	Catalog #
1/8-27NPTF		Standard	655	10-32 Stud	360 086

### Table 4: 100PSI / 7 bar (240-330Ohm) Pressure Senders

Thread	Warning Contact Point	Ground	Component Reference #	Connection	Catalog #
1/8-27NPTF		Standard	734	10-32 Stud	360 811

### Table 5: 150PSI / 10 bar (10-180Ohm) Pressure Senders

Thread	Warning Contact Point	Ground	Component Reference #	Connection	Catalog #
1/4-18NPTF		Standard	29/20	Knurled Nut	360 021
1/8-27NPTF		Standard	29/12	Knurled Nut	360 004
1/8-27NPTF		Standard	3/2	Knurled Nut	<b>362 034</b>
1/8-27NPTF		Floating	1/2	.250" Spade	<b>362 002</b>
1/8-28BSP		Standard	29/62	Knurled Nut	360 081
1/8-27NPTF		Standard	32/14	Knurled Nut	360 430
M10x1.0		Standard	29/10	Knurled Nut	360 015
1/8-27NPTF	11.4 PSI	Standard	30/15	Knurled Nut	360 025
M10x1.0	29.6 PSI	Standard	30/41	Knurled Nut	360 033
M10x1.0	7 PSI	Standard	30/9	Knurled Nut	360 023
M12x1.5	7 PSI	Standard	30/22	Knurled Nut	360 024

"362" series of pressure senders are for dual station (2 pressure gauge) installations



# Pressure Senders & Switches

Thread	Warning Contact Point	Ground	Component Reference #	Connection	Catalog #
1/8-27NPTF		Standard	4/1	.250" Spade	362 035
1/8-27NPTF		Floating	2/1	.250" Spade	362 003
3/8-18NPTF		Standard	38/2	.250" Spade	360 432
1/8-27NPTF		Standard	38/3	M4 Stud	360 431
M14x1.5		Standard	38/1	M4 Stud	360 442

Thread	Warning Contact Point	Ground	Component Reference #	Connection	Catalog #
1/8-27NPTF		Floating	2/3	Knurled Nut	362 004
1/8-27NPTF		Floating	38/8	Knurled Nut	360 406

Thread	Warning Contact Point	Ground	Component Reference #	Connection	Catalog #
1/8-27NPTF		Floating	32/25	.250" Spade	360 043



Pressure Sender



Universal Sender Kits



Pressure Switch

## Heavy-Duty Pressure Switch Technical Specifications:

**Normally Open:** Contacts open until pressure rises which then completes the circuit. **Normally Closed:** Contacts closed until pressure rises which then breaks the circuit. Direct action blade contact pressure switches with adjustable contact ranges: 4-7 PSI +/- 1; 14-24 PSI +/- 3; 51-90 PSI +/- 7

Contacts: Silver alloy	Electrical Ratings
Operating Pressure (Set Point Range) 4-24 PSI = 150 PSI    25-90 PSI = 250 PSI	Resistive: 15 Amp-6 VDC 8 Amp-12 VDC 4 Amp-24 VDC
Proof Pressure: 500 PSI	Inductive: 1 Amp-120 VAC 0.5 Amp-240 VAC
Burst Pressure (Set Point Range) 4-24 PSI = 750 PSI    25-90 PSI = 1,250 PSI	Temperature Range: -40° F to 250° F

Base: Steel plated  
Diaphragm: Polyimide film  
Cover: Glass reinforced polyester  
Terminals: #8-32 screws  
Thread Size: 1/8-27 NPT

Warning Contact Point	Thread	Connection	Circuit	Catalog #
15PSI	1/8-27NPTF	#8-32	Normally Closed	230 515
4PSI	1/8-27NPTF	#8-32	Normally Closed	230 504
60PSI	1/8-27NPTF	#8-32	Normally Closed	230 560

Warning Contact Point	Thread	Connection	Circuit	Catalog #
60PSI	1/8-27NPTF	#8-32	Normally Open	230 460
4PSI	1/8-27NPTF	#8-32	Normally Open	230 404
15PSI	1/8-27NPTF	#8-32	Normally Open	230 415

Warning Contact Point	Thread	Connection	Circuit	Catalog #
60PSI	1/8-27NPTF	#8-32	Normally Open/Normally Closed	230 660
4PSI	1/8-27NPTF	#8-32	Normally Open/Normally Closed	230 604
15PSI	1/8-27NPTF	#8-32	Normally Open/Normally Closed	230 615

**Warning Notice:** VDO pressure senders are not to be used with any type of fuel application. VDO pressure senders may not be used in automotive braking systems. VDO pressure senders are not suitable for use in aircraft.

**"362" series of pressure senders are for dual station (2 pressure gauge) installations**

# Temperature Senders

## Types of senders

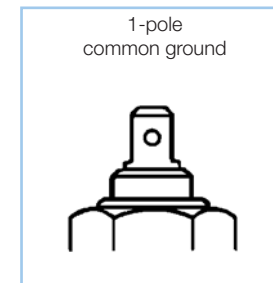

Standard Ground: sender case to common ground

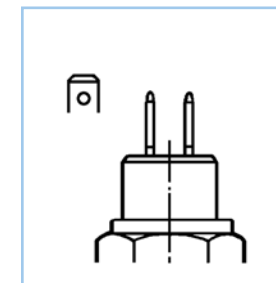

Floating Ground: isolated terminal to common ground

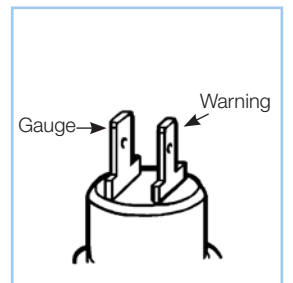

Standard Ground with Warning Contact

## Temperature Sender & Adapter Kits

VDO universal sender kits include 1/8-27NPT common ground temperature sender, spade connector and US thread adapter kit for 1/4-18, 3/8-18 and 1/2-14 NPT threads.

Catalog Number	Description
323 900	250°F/120°C with US Thread Adapters
323 905	300°F/150°C with US Thread Adapters

Thread	Warning Contact Point	Ground	Component Reference #	Connection	Catalog #
1/2-14NPTF		Standard	801/1/16	Knurled Nut	323 419
1/2-14NPTF		Standard	801/1/10	.250" Spade	323 093
1/4-18NPTF		Standard	801/1/9	.250" Spade	323 420
1/8-27NPTF		Standard	801/5/1	.250" Spade	323 095
3/8-18NPTF		Standard	801/1/38	Knurled Nut	323 421
3/8-18NPTF		Standard	801/1/7	.250" Spade	323 094
5/8-18 UNF		Standard	801/1/8	.250" Spade	323 422
1/4-18NPTF		Floating	805/3/1	.250" Spade	325 002
3/8-18NPTF		Floating	805/3/3	.250" Spade	325 007
1/2-14NPTF		Floating	805/1/4	.250" Spade	323 478
3/8-18NPTF		Floating	805/1/5	.250" Spade	323 479
5/8-18 UNF		Floating	805/1/2	.250" Spade	323 483
M14x1.5		Floating	805/1/1	.250" Spade	323 425
M14x1.5		Standard	801/1/26	Knurled Nut	323 416
M16x1.5		Standard	801/1/29	Knurled Nut	323 417
M18x1.5		Standard	801/1/22	.250" Spade	323 418
1/2-14NPTF	205°F	Standard	803/1/19	.250 & .187 Spade	323 098
M14x1.5	205°F	Standard	803/1/6	.250 & .187 Spade	323 102
5/8-18 UNF	209°F	Standard	803/1/2	.250 & .187 Spade	323 026
1/2-14NPTF	217°F	Standard	803/1/25	.250 & .187 Spade	323 099
1/2-14NPTF	230°F	Standard	803/1/32	.250 & .187 Spade	323 100
M16x1.5	230°F	Standard	803/1/7	.250 & .187 Spade	323 028
M10x1.0		Standard	801/17/1	.250" Spade	323 088

Note: All Temperature senders are designed to work with VDO gauges only. Senders are matched to gauges according to maximum reading on dial face. All senders are standard ground (sender case to common ground). Please note: VDO senders have tapered threads and DO NOT require the use of Teflon tape or pipe sealant. This will interfere with grounding causing incorrect instrument readings.

# Temperature Senders

**Table B: 300°F / 150°C Temperature Senders**

Thread	Warning Contact Point	Ground	Component Reference #	Connection	Catalog #
1/2-14NPTF		Standard	801/4/6	M4 Stud	323 060
1/4-18NPTF		Standard	801/4/17	Knurled Nut	323 058
1/8-27NPTF		Standard	801/9/1	.250" Spade	323 057
3/8-18NPTF		Standard	801/4/15	.250" Spade	323 059
1/4-18NPTF		Floating	805/3/2	.250" Spade	323 485
M10x1.0		Standard	801/9/3	.250" Spade	323 423
M12x1.5		Standard	801/10/3	.250" Spade	323 092
M14x1.5		Standard	801/12/2	.250" Spade at 90°	323 055
M16x1.5		Standard	801/12/1	.250" Spade at 90°	323 056
M18x1.5		Standard	801/12/3	.250" Spade at 90°	323 064
1/2-14NPTF	250°F	Standard	803/2/15	.250 & .187 Spade	323 120
M14x1.5		Standard	803/2/7	.250 & .187 Spade	323 121



**Table C: 400°F / 200°C Temperature Senders**

Thread	Warning Contact Point	Ground	Component Reference #	Connection	Catalog #
1/8-27NPTF		Standard	801/13/1	.250" Spade	323 050
1/8-27NPTF		Standard	801/18/1	.250" Spade	323 086
M10x1.5		Standard	801/3/1	.250" Spade	323 091

**Table D: Replacement US Range Coolant and Oil Temperature Senders**

Description	Range	Thread	Connection	Catalog #
Temperature Sender 240°F 1/8-27NPTF	240F	1/8-27NPTF	#8-32	323 500
Temperature Sender 280°F 1/8-27NPTF	280F	1/8-27NPTF	#8-32	323 501
Temperature Sender 320°F 1/8-27NPTF	320F	1/8-27NPTF	#8-32	323 502

**Table E: Air, Cylinder and Exhaust Temperature Senders**

Description	Range	Thread	Connection	Catalog #
Outside Air, for Viewline	185°F		Unterminated Wire Lead	323-112
Outside Air, for Vision Gauges	120°F	M10x1.0	M4 Stud	323 087
Pyrometer Sender, for Ocean Line, Severe Duty and Viewline	1650°F	1/4-18NPTF	#6 Ring Terminal	326 001
Pyrometer Thermocouple	1650°F	1/4-18NPTF	#6 Ring Terminal	323 892
Pyrometer Thermocouple and Weld-on Adapter	1650°F	1/4-18NPTF	#6 Ring Terminal	323 903

# Temperature Switches

**Temperature Switch Technical Specifications:**

**Switching Capacity:** 1.2W to 3W, non-inductive for monitoring various mediums

**Normally Open, Single Circuit, Standard Ground Systems**

**Rated Voltage:** 6V to 24V

**Type of Contact:** SS = contact closes as temperature rises

**Break Point:** 5° C max. below make point

**Contacting Mode:** Slow-acting

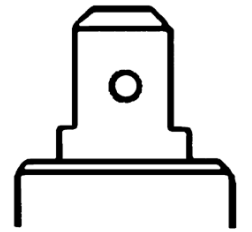

**Types of switches**

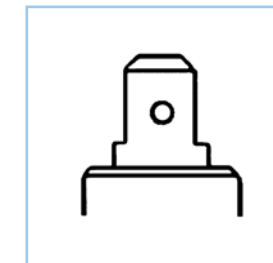

Connection: .250"

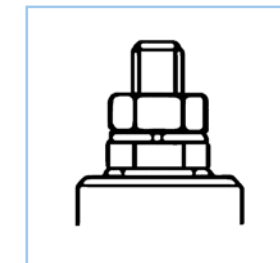

Connection: M4 Stud

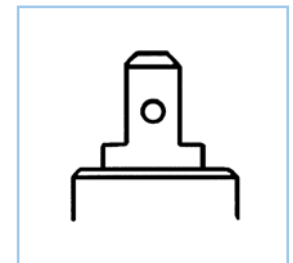

Connection: .187"

**Temperature Switches**

Warning Contact Point	Thread	Connection	Circuit	Catalog #
158°F	M14x1.5	.250" Spade	Normally Open	232 013
194°F	M10x1.5	M4 Stud	Normally Open	232 001
203°F	1/2-14NPTF	.250" Spade	Normally Open	232 012
205°F	1/8-27NPTF	M4 Stud	Normally Open	232 007
217°F	1/2-14NPTF	.250" Spade	Normally Open	232 015
217°F	3/8-18NPTF	.250" Spade	Normally Open	232 017
221°F	1/2-14NPTF	.250" Spade	Normally Open	232 005
221°F	3/8-18NPTF	.187 Spade	Normally Open	232 019
230°F	M10x1.0	M4 Stud	Normally Open	232 009
230°F	M14x1.5	.250" Spade	Normally Open	232 011
248°F	1/2-14NPTF	M4 Screw	Normally Open	232 010
248°F	3/4-16UNF	.250" Spade	Normally Open	232 018
275°F	M10x1.5	M4 Stud	Normally Open	232 021
302°F	M10x1.5	M4 Stud	Normally Open	232 006
338°F	M10x1.5	M4 Stud	Normally Open	232 002
383°F	M10x1.5	M4 Stud	Normally Open	232 020



# Speed, Position and Tachometer Senders

Generator Senders	
Description	Catalog #
Generator Sender 7/8-18, 4 Pulse	340 001
Generator Sender M22X1.5, 4 Pulse	340 002
Generator Sender with Odometer/Revolution Counter 7/8-18, 4 Pulse	340 008
Generator Sender with Odometer/Revolution Counter M22X1.5, 4 Pulse	340 007



340 001

Inductive Sender	
Description	Catalog #
Inductive Sender, Magnetic Pickup 2"	340 020



340 020

Rudder Angle Position Senders	
Description	Catalog #
Position Indicator Sender 0-90 Ohm, Dual Station	440 004
Position Indicator Sender 10-180 Ohm, Single Station	440 003



440 003

Speed Senders	
Description	Catalog #
Replacement Pitot Sender	270 105
Transom Mount Speed/Depth/Water Temperature Sender Kit for Viewline Sumlog	402 002
Thru Hull Speed/Depth Water Temperature Sender Kit for Viewline Sumlog	402 003
Pitot Speedometer Sender and Tubing Kit	270 900
GPS Speed Sender	340 786



270 900



## VDO Fuel and Water Level Senders

Today more than ever, due to tank configurations, you need choices when it comes to designing new systems. VDO gives you those choices, from simple economical solutions to ones that give you integrated delivery and return tubes.

Our original ALAS design, which has been often copied in the industry but never duplicated in its quality or durability, is now joined by two new designs, ALAS I & ALAS II. On the following pages you can see the features of each design and decide for yourself which best meet your requirements.

- **ALAS** (adjustable length arm sender)
- **ALAS I** (adjustable length arm sender with low warning contact)
- **ALAS II** (adjustable length arm sender with low warning contact, draw & return tubes)
- **Tube Type** (compact tubular resistive design)
- **Water Level Senders**

# VDO ALAS Plated Steel 12/24V Adjustable Swing Arm Sender

Designed for severe duty use, each of these senders contains an SAE standard five hole metal mounting flange and body components which can be adjusted from 6" to 23" tank depth. Adaptable to right hand or left hand swing arm. Each contains thick film resistor technology for greater resistance to wear associated with standard wire wound units. Each kit contains neoprene mounting gasket and mounting screws. For tanks without flange mounting holes our optional tank mounting kit may be used.

1. SAE 5-hole mounting flange can rotate to position sender for right or left hand swing.
2. Body constructed of plated steel to eliminate damage caused by fuel slosh.
3. Swing arm pivot uses oversized bearings for long life.
4. Adjustable for tank depths from 152mm to 584mm.
5. Wiper and thick film resistor are shielded from fuel slosh for maximum durability.
6. Float arm stops ensure wiper remains in contact with resistor board when tank is full or low.

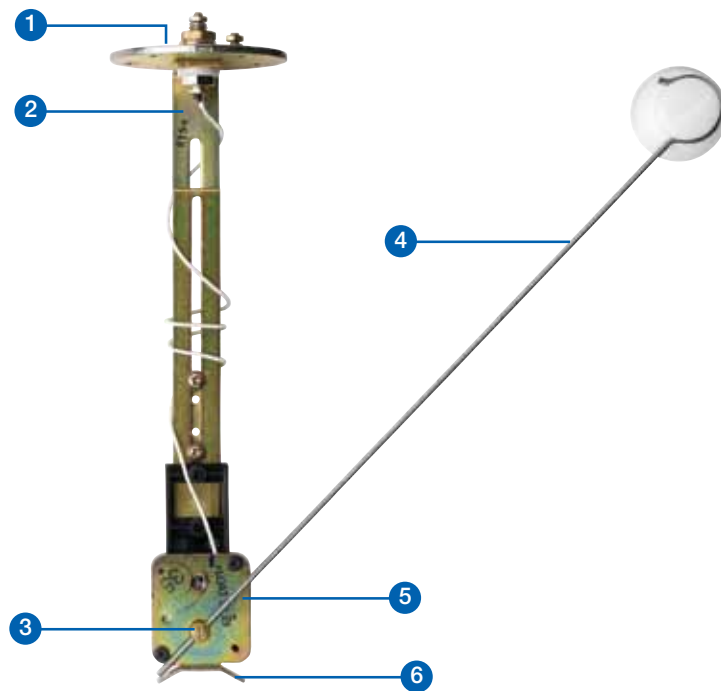

ALAS Fuel Senders			
Description	Component Reference	Mounting Diameter	Catalog #
ALAS Adjustable Fuel Sender 6 3/4"-23", 0-90 Ohm	1-551-004-161D	54mm	226 008
ALAS Adjustable Fuel Sender 6 3/4"-23", 10-184 Ohm	1-551-004-082B	54mm	226 001
ALAS Adjustable Fuel Sender 6 3/4"-23", 10-184 Ohm, with Tank Flange	1-551-004-082B	54mm	226 002
ALAS Adjustable Fuel Sender 6 3/4"-23", 240-33 Ohm	1-551-004-123D	54mm	226 007

0-90Ohm for dual station applications

# VDO ALAS I 12/24V Fuel Senders

**An economical and practical solution for fuel monitoring for tank depths from 140mm to 400mm**

Engineered with a redundant dual wiper system, our unique VDO 'quiet arm' and thick film technology, VDO ALAS I leads the field in reliability and durability. In fact, this family of senders has the ability to withstand over one million swing arm cycles without failure. ALAS I senders feature our unique slotted SAE five-hole flange mount, an industry first that gives you the utmost in versatility for sender mounting positions.

Three resistance values are available, 10-180 ohm, 240-33 ohm & 0-90 ohm. ALAS I senders are available with an optional low fuel warning contact circuit found in no other universal type sender.

Upon request, we can supply senders fully assembled to your specifications.

1. Available with low fuel warning contact.
2. Redundant ground connection.
3. Unique SAE 5-hole slotted mounting plate allows for positioning sender for left or right hand applications.
4. Stainless steel float arm and pivot adjusts from 140mm to 400mm.
5. "No sink" solid float.
6. Steel reinforced mounting hardware (included with single packed senders).
7. VDO thick film element with 39-step resolution.
8. Redundant dual wiper system.
9. 'Quiet arm' minimizes float movement.

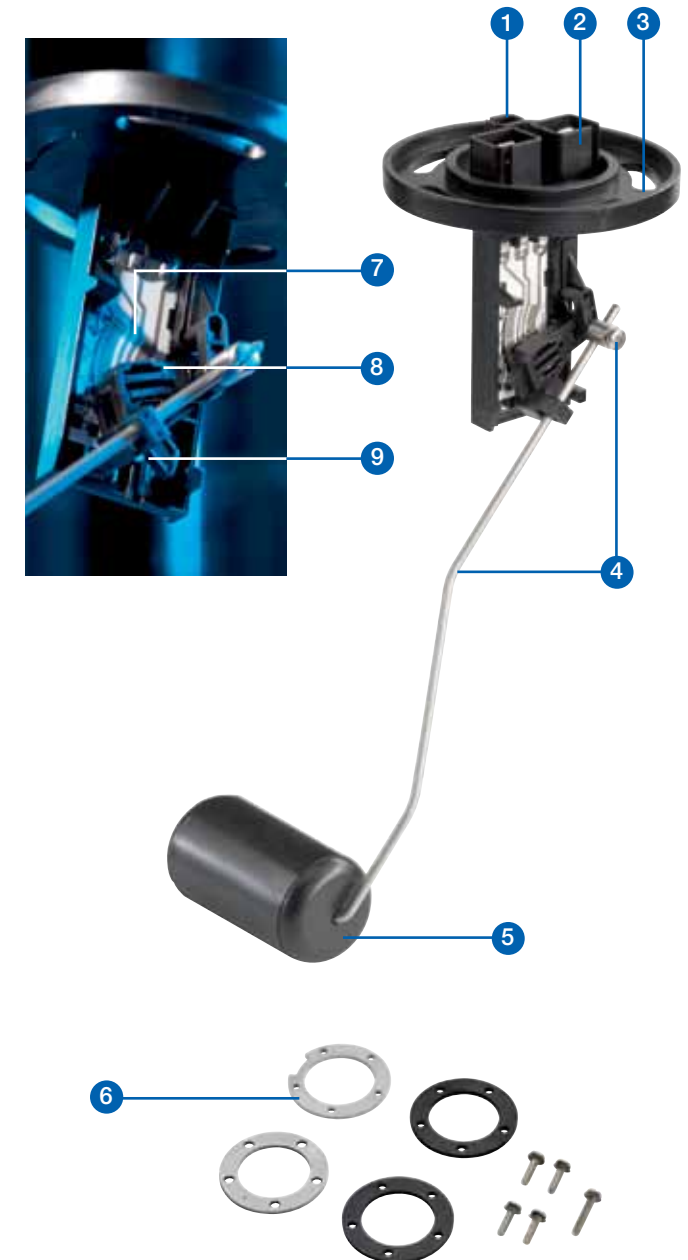

ALAS I Fuel Senders				
Description	Warning contact	Component Reference	Mounting Diameter	Catalog #
ALAS I Adjustable Fuel Sender, 6-15 3/4", 3-180 Ohm, with Low Fuel Warning Contact	Yes	A2C59510162	54mm	226 162
ALAS I Adjustable Fuel Sender, 6-15 3/4", 240-33 Ohm, with Low Fuel Warning Contact	Yes	A2C59510163	54mm	226 163
ALAS I Adjustable Fuel Sender, 6-15 3/4", 0-90 Ohm, with Low Fuel Warning Contact	Yes	A2C59510164	54mm	226 164



# ALAS II 12/24V Fuel Senders with Draw / Return Tubes

Again, VDO is first to market with the only adjustable fuel sender featuring interchangeable draw / return tubes, plus standard low fuel warning contact. Just pick the length and diameter of the draw / return tubes based on your gas or diesel application, set the float length and you're ready for installation.

If you have several tank configurations, inventory is minimized with our 'one size fits all' design, without compromising the durability or integrity of the sender. These units are fully adjustable from 140mm to 400mm.

Engineered with a redundant dual wiper system, the unique VDO 'quiet arm' and thick film technology, ALAS II leads the field in reliability and durability. In fact, this family of senders has the ability to withstand over one million swing arm cycles without failure. VDO ALAS II senders feature our unique slotted SAE 5-hole flange mount, an industry first that gives you the utmost in versatility for sender mounting positions.

Three resistance values are available, 10-180 ohm, 240-33 ohm and 90-0 ohm. ALAS II senders come with a standard low fuel warning contact circuit that is not offered in other universal type senders.

Upon request, we can supply senders fully assembled to your specifications.

Each draw / return tube has 360° of positioning capability within the flange to meet your specific application.

Draw / return tubes available in four different diameters (6.5mm, 8mm, 10 and 12mm), accommodating tank depths up to 400mm.

Where return tubes are not required, a port plug is available.



## ALAS II Platform:

1. Steel reinforced mounting hardware.
2. Standard with low fuel warning contact.
3. Redundant ground connection.
4. Unique SAE 5-hole slotted mounting plate allows for positioning sender for left or right hand applications.
5. Stainless steel float arm and pivot adjusts from 140mm to 400mm.
6. 'No sink' solid float.
7. VDO thick film element with 39-step resolution.
8. Redundant dual wiper system.
9. 'Quiet arm' minimizes float movement.

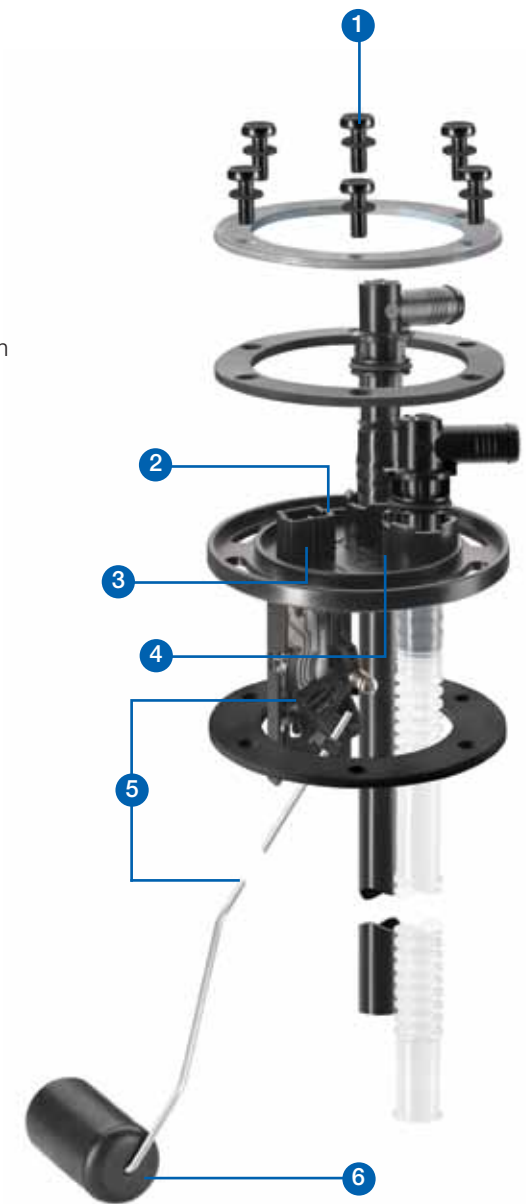

## ALAS II Fuel Sender Installation Kit and Draw & Return Tubes

Step	Item	Part Number
Step 1: Required installation kit	Installation Kit	226 985
Step 2: Select draw tube	Tube inside diameter	Single
	6.5mm	226 955
	8.0mm	226 953
	10.0mm	226 951
Step 3: Select return tube	Tube inside diameter	Single
	6.5mm	226 956
	8.0mm	226 954
	10.0mm	226 952
Step 4: (optional - if 1 or both tubes are not required)	port plug	226 965
	(required) wire harness connector with 24" lead	A2C59519722-S



# VDO Tube Type 12/24V Fuel Senders

Our VDO tube type fuel senders are considered to be the most robust fuel sender in our product offering today.

The advantage of a tube type sender is that it uses the least amount of space within a tank, with no worries about float arm direction. The float is contained within the aluminum cylindrical housing, and it rides on two resistive wires that protect it from the 'extreme fuel sloshing' that occurs in many shallow, large or odd sized tanks.

VDO tube type fuel senders feature a standard SAE 5-hole mounting flange and can fit tanks depths from 150mm to 800mm.

- Suitable for gasoline and diesel fuels.
- Ideal for situations where fuel slosh is problematic.
- Aluminum flange and housing can withstand extreme environments, where dust or salt water spray are present.
- Available in 34 standard lengths from 150mm (~6in) to 800mm (~31 1/2 in).
- M4 stud and .250" spade connections provided with each sender.
- Supplied with neoprene mounting gasket.

## VDO tubular level sensor

- |                      |                        |
|----------------------|------------------------|
| 1. Mounting flange.  | 5. Guide bar.          |
| 2. Resistance wires. | 6. Protecting tube.    |
| 3. Contact springs.  | 7. Insulating piper.   |
| 4. Float.            | 8. Liquid access hole. |

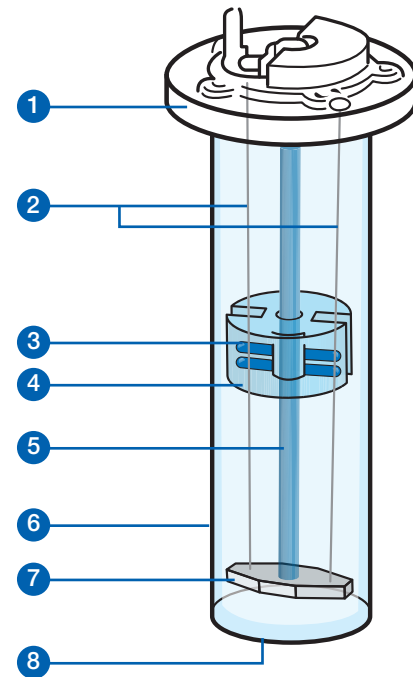

Tube Type Fuel Level Senders				
Mounting Dia.	Mounting Depth	Component Ref. #	Connection	Catalog #
54mm	150mm / 6 in	224-011-000-150X	interchangeable: .250 Spade or M4 Stud	224 215
54mm	160mm / 6.3 in	224-011-000-160X	interchangeable: .250 Spade or M4 Stud	224 216
54mm	170mm / 6.7 in	224-011-000-170X	interchangeable: .250 Spade or M4 Stud	224 217
54mm	180mm / 7.1 in	224-011-000-180X	interchangeable: .250 Spade or M4 Stud	224 218
54mm	190mm / 7.5 in	224-011-000-190X	interchangeable: .250 Spade or M4 Stud	224 219
54mm	200mm / 7.9 in	224-011-000-200X	interchangeable: .250 Spade or M4 Stud	224 220
54mm	210mm / 8.3 in	224-011-000-210X	interchangeable: .250 Spade or M4 Stud	224 221
54mm	220mm / 8.7 in	224-011-000-220X	interchangeable: .250 Spade or M4 Stud	224 222
54mm	230mm / 9.1 in	224-011-000-230X	interchangeable: .250 Spade or M4 Stud	224 223
54mm	250mm / 9.9 in	224-011-000-250X	interchangeable: .250 Spade or M4 Stud	224 225
54mm	260mm / 10.3 in	224-011-000-260X	interchangeable: .250 Spade or M4 Stud	224 226

Tube Type Fuel Level Senders continued on next page

# Fuel and Water Level Senders

Tube Type Fuel Level Senders				
Mounting Dia.	Mounting Depth	Component Ref. #	Connection	Catalog #
54mm	270mm / 10.7 in	224-011-000-270X	interchangeable: .250 Spade or M4 Stud	224 227
54mm	280mm / 11.1 in	224-011-000-280X	interchangeable: .250 Spade or M4 Stud	224 228
54mm	290mm / 11.5 in	224-011-000-290X	interchangeable: .250 Spade or M4 Stud	224 229
54mm	300mm / 11.9 in	224-011-000-300X	interchangeable: .250 Spade or M4 Stud	224 230
54mm	310mm / 12.3 in	224-011-000-310X	interchangeable: .250 Spade or M4 Stud	224 231
54mm	320mm / 12.6 in	224-011-000-320X	interchangeable: .250 Spade or M4 Stud	224 232
54mm	330mm / 13.2 in	224-011-000-330X	interchangeable: .250 Spade or M4 Stud	224 233
54mm	340mm / 13.4 in	224-011-000-340X	interchangeable: .250 Spade or M4 Stud	224 234
54mm	350mm / 13.8 in	224-011-000-350X	interchangeable: .250 Spade or M4 Stud	224 235
54mm	360mm / 14.2 in	224-011-000-360X	interchangeable: .250 Spade or M4 Stud	224 236
54mm	370mm / 14.6 in	224-011-000-370X	interchangeable: .250 Spade or M4 Stud	224 237
54mm	380mm / 15 in	224-011-000-380X	interchangeable: .250 Spade or M4 Stud	224 238
54mm	390mm / 15.4 in	224-011-000-390X	interchangeable: .250 Spade or M4 Stud	224 239
54mm	400mm / 15.8 in	224-011-000-400X	interchangeable: .250 Spade or M4 Stud	224 240
54mm	450mm / 17.8 in	224-011-000-450X	interchangeable: .250 Spade or M4 Stud	224 245
54mm	500mm / 19.7 in	224-011-000-500X	interchangeable: .250 Spade or M4 Stud	224 250
54mm	550mm / 21.7 in	224-011-000-550X	interchangeable: .250 Spade or M4 Stud	224 255
54mm	600mm / 23.7 in	224-011-000-600X	interchangeable: .250 Spade or M4 Stud	224 260
54mm	650mm / 25.6 in	224-011-000-650X	interchangeable: .250 Spade or M4 Stud	224 265
54mm	700mm / 27.6 in	224-011-000-700X	interchangeable: .250 Spade or M4 Stud	224 270
54mm	750mm / 29.6 in	224-011-000-750X	interchangeable: .250 Spade or M4 Stud	224 275
54mm	800mm / 31.5 in	224-011-000-800X	interchangeable: .250 Spade or M4 Stud	224 280
80mm	882.65mm / 34.8 in		.250" Spade	224 074
80mm	916mm / 36.1 in		.250" Spade	224 052
80mm	1086mm / 42.8 in		M5 Stud	224 075

## Water Level Senders

Constructed of durable stainless steel, these senders are designed for fresh and blackwater applications as indicated. Mounting hardware is supplied with each sender.

Water Type	Sender Type	Mounting Depth	Mounting Dia.	Catalog #
Freshwater	Capacitive	1200-1500mm / 47.2-59.0 in	54mm	226 455
Freshwater	Capacitive	600-1200mm / 23.5-47.2 in	54mm	226 454
Freshwater	10-180 Ohm	203mm to 584mm / 8.0-23.0 in	54mm	226 452
Freshwater	Capacitive	80-600mm / 3.1-23.5 in	54mm	226 453
Wastewater	Capacitive	1200-1500mm / 47.2-59.0 in	54mm	226 458
Wastewater	Capacitive	600-1200mm / 23.5-47.2 in	54mm	226 457
Wastewater	Capacitive	80-600mm / 3.1-23.5 in	54mm	226 456





# Instrument Accessories and Service Parts

## Steel Mounting Bracket

240 027	1 Gauge Mounting Bracket - for 2 1/16" Gauges - Black
240 034	1 Gauge Mounting Bracket - for 2 1/16" Gauges - Chrome
240 028	2 Gauge Mounting Bracket - for 2 1/16" Gauges - Black
240 035	2 Gauge Mounting Bracket - for 2 1/16" Gauges - Chrome
240 029	3 Gauge Mounting Bracket - for 2 1/16" Gauges - Black
240 036	3 Gauge Mounting Bracket - for 2 1/16" Gauges - Chrome

## Steel Mounting Cup

240 016	Steel Mounting Cup Kit for 2 1/16" Gauges - Black
240 017	Steel Mounting Cup Kit for 2 1/16" Gauges - Chrome
240 018	Steel Mounting Cup Kit for 3 9/16" Gauges - Black
240 019	Steel Mounting Cup Kit for 3 9/16" Gauges - Chrome

## Mounting Cup

240 101	Plastic Mounting Cup for 2 1/16" Gauges - Black
240 102	Plastic Mounting Cup for 3 1/8" Gauges - Black

## Rubber Mounting Brackets

240 802	1 Gauge Rubber Mounting Bracket for 2 1/16" Gauges
240 803	2 Gauge Rubber Mounting Bracket for 2 1/16" Gauges
240 804	3 Gauge Rubber Mounting Bracket for 2 1/16" Gauges

## Anti-Glare Rings

240 005	Anti-Glare ring for 2 1/16" Gauges - Pair
---------	---

## Stud Mounting Kits

600 402	Stud Mount Conversion Kit for 2 1/16" Vision and Cockpit Series Gauges
600 401	Stud Mount Conversion Kit for 3 1/8" and 3 9/16" Vision and Cockpit Series Gauges

## Spin-Lok™ Mounting Rings (Replacement)

600 404	2 1/16" (52mm) for All VDO Instruments
600 415	3 9/16" (85mm) for Viewline
600 406	3 9/16" (85mm) for Vision, Cockpit and Series 1 Instruments
600 416	4 3/8" (110mm) for Viewline
600 403	4" (100MM) for Vision and Cockpit Series Instruments

## Flush Mounting Kits

600 413	Back Mount Bracket and Gasket for 1 Viewline Instrument
---------	---

## Reducer Rings

600 851	Reducing Ring 2 9/16" to 2 1/16"
600 885	Reducing Ring 3 9/16" to 3 1/8"

## Instrument Panel Hole Covers

240 864	Instrument Panel Hole Cover, 2 1/16"
600 508	Instrument Panel Hole Cover, 2 1/16", Square Front
240 866	Instrument Panel Hole Cover, 3 9/16"

## 85MM Ocean Line & Severe Duty Bezels

600 002	Square Bezel for 85mm Ocean Line & Severe Duty Instruments
---------	--

## Optional Black Square Bezels

600 001	Square Bezel for 52mm Ocean Line & Severe Duty Instruments
---------	--



600 402



Mounting Brackets



Spin-Lok™ Mounting Rings



Mounting Cups



Adjustable Mounting Cups



Instrument Panel Hole Cover

# Instrument Accessories and Service Parts

## Warning Buzzer

407 1101	Panel Mounted Warning Buzzer with Black Bezel
407 4101	Panel Mounted Warning Buzzer with Chrome Bezel

## Tubing Kits

150 855	0-150 PSI Nylon Tubing Kit, 16ft
150 851	0-150 PSI Nylon Tubing Kit, 6ft
150 856	0-400 PSI Copper Tubing Kit, 16ft

## Complete Wiring Harnesses for Viewline

240 037	Instrument Wiring Harness for 5 or 6 Viewline Gauges
---------	--

## Complete Wiring Harness for Vision & Cockpit Gauges

240 030	Instrument Wiring Harness for 5 or 6 Vision or Cockpit Gauges, Speed/Tach Centered
240 031	Instrument Wiring Harness for 5 or 6 Vision or Cockpit Gauges, Speed/Tach Off-Centered

## Single Gauge Wiring Harness for Vision, Cockpit and Series 1

240 023	1 Gauge Universal Wiring Kit (Except Viewline)
---------	--

## Wiring Harness & Accessories for Vision, Cockpit and Series 1 Instruments

240 025	3 prong Connector for Vision & Cockpit Series
240 026	3 prong Connector with Terminals
240 053	6 Pole Connector for Vision, Cockpit and Series 1 Speedometers and Tachometers without LCD
240 024	8 pole Connector for Vision, Cockpit and Series 1 Speedometers and Tachometers with LCD
240 045	M4 Stud to .250" Blade Terminal Adapter

## Universal Ammeter Wiring Kit (Except Viewline)

240 021	1 Gauge Universal Ammeter Wiring Kit (Except Viewline)
---------	--

## Ocean Link Wire Harness

A2C53092432	Input Harness to Master. Supports CAN & Two Analog Inputs
-------------	---

## Pyrometer Cables

326 002	Pyrometer Cable for Viewline & Ocean Line/Severe Duty, 13ft
240 092	Pyrometer Extension Cable, 30ft

## Adapters & Fittings

240 828	Angle Adapter 1/8-27NPTF male X 1/8-27NPTF female
240 903	Brass Adapters, includes 1/8-27NPTF to 1/4-18, 9/16-18 and 1/2-14
240 904	Brass Adapters, includes 1/8-27NPTF to: M16x1.5, M14x1.5, M12x1.5, M10x1 and 1/8-28BSP
240 855	Brass T Adapter 1/8-27NPTF
240 850	Brass T Adapter M10 X 1
240 863	Weld on Threaded nut for Mounting Pyrometer Sender

## Air, Cylinder and Exhaust Temperature Sender Parts

240 701	Cylinder Head Temperature Sender Harness, 15ft
240 702	Pyrometer Cable for Vision & Cockpit International, 12ft

## Drive Keys for generator senders

340 065	Drive Key .104"
340 060	Drive Key .152"
340 061	Drive Key .187"
340 064	Drive Key .2"
340 062	Drive Key .203"



240 022



240 023



240 026



Nylon Tubing Kits



Copper Tubing Kits

# Instrument Accessories and Service Parts

## Fuel & Water Sender Service Parts

226 985	ALAS II Fuel Sender Installation Kit
600 408	Bolt on Flange Kit for Lever Arm Type Fuel Senders
226 479	Replacement Float Arm with Float
600 601	Replacement Float for ALAS Fuel Senders
226 053	Replacement Neoprene Fuel Sender Gasket - SAE 5 Hole
226 451	SAE 5 Hole Mounting Flange Kit

## Position Indicator Senders Service Parts

440 100	Lever Assembly for Position Indicator Senders
440 050	Position Indicator Mounting Kit

## Makepoint Switch

A2C59510886-S	Makepoint Switch for Viewline Warning Light - 1 req. per Instrument
---------------	---

## Resistors & Resistors Kits

391 706	Resistor for Ocean Line & Severe Duty Instruments, 12V to 24V
391 704	Resistor Kit 12V to 24V with Type A Bulb
A2C59510221-S	Resistor Kit for Viewline Instruments, 12V to 24V
391 101	Resistor Kit for Vision & Cockpit International with Peanut Bulb, 12V to 24V
391 102	Resistor Kit for Vision & Cockpit International with Wedge Bulb, 12V to 24V
391 103	Resistor Kit for Vision, Cockpit and Series 1 3 3/8" Tachometers without Hourmeters, 12V to 24V

## Shunts

391 302	100A Shunt For Viewline Ammeter
391 303	150A Shunt For Viewline Ammeter
391 007	150A Shunt for Vision
391 300	30A Shunt For Viewline Ammeter
391 301	60A Shunt For Viewline Ammeter

## Replacement Bulb Sockets

600 817	Type A Brass Bulb Socket
600 813	Type A Plastic Bulb Socket
600 816	Type A Steel Bulb Socket
600 819	Type B Plastic Bulb Socket
600 818	Type B Steel Bulb Socket
600 840	Type E Plastic Bulb Socket

## Panel Mount Warning Lights

	Lighting Color	Voltage
600 844 B LED	Blinking Red LED Warning Light with Socket & Pigtail	Red 12V
600 847 LED	Blue LED Warning Light with Socket & Pigtail	Blue 12V
600 847	Blue Snap in Panel Light, 12V	Blue 12V
600 845 LED	Green LED Warning Light with Socket & Pigtail	Green 12V
600 845	Green Snap in Panel Light, 12V	Green 12V
600 844 LED	Red LED Warning Light with Socket & Pigtail	Red 12V
600 844	Red Snap in Panel Light, 12V	Red 12V
600 846 LED	Yellow LED Warning Light with Socket & Pigtail	Yellow 12V
600 846	Yellow Snap in Panel Light, 12V	Yellow 12V



A2C59510221-S



Warning Lights

# Instrument Accessories and Service Parts



LED Replacement Bulbs

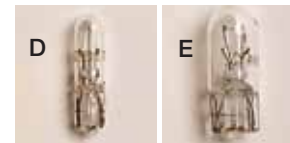
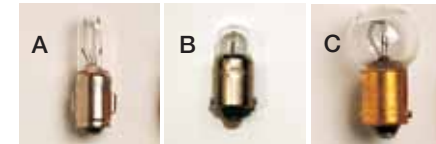

600 813 600 819 600 823



600 840 600 816



600 821 600 818



Light Diffusers

## Original Replacement Bulbs

		Voltage
600 802	Type A 9/32" (7mm) Metal Base Bulb, 12V, 2W, 4 Pack	12V
600 807	Type A 9/32" (7mm) Metal Base Bulb, 24V, 3W, 4 Pack	24V
600 804	Type B 11/32" (9mm) Metal Base Bulb, 12V, 2W, 4 Pack	12V
600 806	Type B 11/32" (9mm) Metal Base Bulb, 12V, 4W, 4 Pack	24V
600 809	Type D Wedge Based Peanut Bulb, 12V, 1.2W, 4 Pack	12V
600 815	Type E Wedge Based Bulb, 12V 3.4W, 4 Pack	12V

## Replacement Bulbs

		Voltage
600 820	Type C 3/8" (10mm) Metal Base Bulb, 12V, 2W, 4 Pack	12V
600 829	Type D Wedge Based Peanut Bulb, 24V, 1.2W, 4 Pack	24V
600 824	Type D Wedge Based Peanut Bulb, red, 12V, 1.2W, 4 Pack	12V
600 822	Type D Wedge Based Peanut Bulb, red, 24V, 1.2W, 4 Pack	24V
600 826	Type E Wedge Based Bulb, 24V 3W, 4 Pack	24V

## Upgrade Replacement Bulbs

		Lighting Color
600 881	Amber LED Wedge Type Bulb (Type E) Upgrade, 1 Bulb	Amber
600 880	Blue LED Wedge Type Bulb (Type E) Upgrade, 1 Bulb	Blue
600 879	Green LED Wedge Type Bulb (Type E) Upgrade, 1 Bulb	Green
600 886	HID White LED Wedge Type Bulb (Type E) Upgrade, 1 Bulb	White
600 878	Red LED Wedge Type Bulb (Type E) Upgrade, 1 Bulb	Red

## Light Diffusers

600 864	Amber Light Diffusers for Type C and E Wedge Bulbs - 4pack
600 863	Blue Light Diffusers for Type C and E Wedge Bulbs - 4pack
600 856	Green Light Diffusers for Type A Bulb - 4 pack
600 862	Green Light Diffusers for Type C and E Wedge Bulbs - 4pack
600 860	Green Light Diffusers for Type D Peanut Bulb - 4 pack
600 853	Red Light Diffusers for Type A Bulb, 4 Pack
600 857	Red Light Diffusers for Type B Bulb, 4 Pack
600 861	Red Light Diffusers for Type C and E Wedge Bulbs, 4 Pack
600 859	Red Light Diffusers for Type D Peanut Bulb, 4 Pack

## Replacement Warning Light for Ocean Line & Severe Duty Instruments

05 800 762	Red Warning Light with Socket, 12V
05 800 764	Red Warning Light with Socket, 24V



**Continental**

**Commercial Vehicles & Aftermarket**

6755 Snowdrift Road

Allentown, PA 18106

USA

Tel: (610) 289-0488

Fax: (610) 289-1766

E-mail: [salesupport-us@vdo.com](mailto:salesupport-us@vdo.com)

[www.vdo.com/usa](http://www.vdo.com/usa)

VDO - A Trademark of the Continental Corporation

**Customer Service**

Tel: (800) 564-5066 or (610) 366-8489

Fax: (800) 752-7224 or (610) 366-9837

**Technical Support**

Tel: (800) 265-1818 or (610) 289-1390

Email: [techsupport-us@vdo.com](mailto:techsupport-us@vdo.com)

We reserve the right to make changes in availability as well as technical changes without prior notice.

Not intended for aircraft applications.

Cat. No. 660-67519-00 | English © 2012

Continental Corporation

Printed in the USA

